

# User's Manual

---

Software Version: 2.11.2

Date: 2017/03/13



Center for Applied Scientific Computing  
Lawrence Livermore National Laboratory

---

Copyright (c) 2008, Lawrence Livermore National Security, LLC. Produced at the Lawrence Livermore National Laboratory. This file is part of HYPRE. See file COPYRIGHT for details.

HYPRE is free software; you can redistribute it and/or modify it under the terms of the GNU Lesser General Public License (as published by the Free Software Foundation) version 2.1 dated February 1999.

# Contents

<b>1</b>	<b>Introduction</b>	<b>1</b>
1.1	Overview of Features . . . . .	1
1.2	Getting More Information . . . . .	2
1.3	How to get started . . . . .	3
1.3.1	Installing <i>hypr</i> . . . . .	3
1.3.2	Choosing a conceptual interface . . . . .	3
1.3.3	Writing your code . . . . .	5
<b>2</b>	<b>Structured-Grid System Interface (Struct)</b>	<b>7</b>
2.1	Setting Up the Struct Grid . . . . .	8
2.2	Setting Up the Struct Stencil . . . . .	10
2.3	Setting Up the Struct Matrix . . . . .	10
2.4	Setting Up the Struct Right-Hand-Side Vector . . . . .	13
2.5	Symmetric Matrices . . . . .	14
<b>3</b>	<b>Semi-Structured-Grid System Interface (SStruct)</b>	<b>17</b>
3.1	Block-Structured Grids with Stencils . . . . .	18
3.2	Block-Structured Grids with Finite Elements . . . . .	23
3.3	Structured Adaptive Mesh Refinement . . . . .	26
<b>4</b>	<b>Finite Element Interface</b>	<b>29</b>
4.1	Introduction . . . . .	29
4.2	A Brief Description of the Finite Element Interface . . . . .	30
<b>5</b>	<b>Linear-Algebraic System Interface (IJ)</b>	<b>33</b>
5.1	IJ Matrix Interface . . . . .	33
5.2	IJ Vector Interface . . . . .	35
5.3	A Scalable Interface . . . . .	36
<b>6</b>	<b>Solvers and Preconditioners</b>	<b>37</b>
6.1	SMG . . . . .	39
6.2	PFMG . . . . .	40
6.3	SysPFMG . . . . .	40

6.4	SplitSolve . . . . .	40
6.5	FAC . . . . .	40
6.6	Maxwell . . . . .	41
6.7	Hybrid . . . . .	43
6.8	BoomerAMG . . . . .	43
	6.8.1 Parameter Options . . . . .	43
	6.8.2 Coarsening Options . . . . .	44
	6.8.3 Interpolation Options . . . . .	44
	6.8.4 Non-Galerkin Options . . . . .	45
	6.8.5 Smoother Options . . . . .	45
	6.8.6 AMG for systems of PDEs . . . . .	46
	6.8.7 Special AMG Cycles . . . . .	46
	6.8.8 Miscellaneous . . . . .	46
6.9	AMS . . . . .	46
	6.9.1 Overview . . . . .	47
	6.9.2 Sample Usage . . . . .	48
	6.9.3 High-order Discretizations . . . . .	51
	6.9.4 Non-conforming AMR Grids . . . . .	52
6.10	ADS . . . . .	53
	6.10.1 Overview . . . . .	53
	6.10.2 Sample Usage . . . . .	54
	6.10.3 High-order Discretizations . . . . .	56
6.11	The MLI Package . . . . .	57
6.12	ParaSails . . . . .	58
	6.12.1 Parameter Settings . . . . .	58
	6.12.2 Preconditioning Nearly Symmetric Matrices . . . . .	59
6.13	Euclid . . . . .	59
	6.13.1 Overview . . . . .	60
	6.13.2 Setting Options: Examples . . . . .	61
	6.13.3 Options Summary . . . . .	62
6.14	<i>PILUT</i> : Parallel Incomplete Factorization . . . . .	63
6.15	LOBPCG Eigensolver . . . . .	64
6.16	FEI Solvers . . . . .	64
	6.16.1 Solvers Available Only through the FEI . . . . .	65
<b>7</b>	<b>General Information</b> . . . . .	<b>69</b>
	7.1 Getting the Source Code . . . . .	69
	7.2 Building the Library . . . . .	69
	7.2.1 Configure Options . . . . .	70
	7.2.2 Make Targets . . . . .	71
	7.3 Testing the Library . . . . .	71
	7.4 Linking to the Library . . . . .	72

7.5	Error Flags . . . . .	72
7.6	Bug Reporting and General Support . . . . .	73
7.7	Using HYPRE in External FEI Implementations . . . . .	73
7.8	Calling HYPRE from Other Languages . . . . .	74



# Chapter 1

## Introduction

This manual describes *hypre*, a software library of high performance preconditioners and solvers for the solution of large, sparse linear systems of equations on massively parallel computers [14]. The *hypre* library was created with the primary goal of providing users with advanced parallel preconditioners. The library features parallel multigrid solvers for both structured and unstructured grid problems. For ease of use, these solvers are accessed from the application code via *hypre*'s conceptual linear system interfaces [13] (abbreviated to *conceptual interfaces* throughout much of this manual), which allow a variety of natural problem descriptions.

This introductory chapter provides an overview of the various features in *hypre*, discusses further sources of information on *hypre*, and offers suggestions on how to get started.

### 1.1 Overview of Features

- **Scalable preconditioners provide efficient solution on today's and tomorrow's systems:** *hypre* contains several families of preconditioner algorithms focused on the scalable solution of *very large* sparse linear systems. (Note that small linear systems, systems that are solvable on a sequential computer, and dense systems are all better addressed by other libraries that are designed specifically for them.) *hypre* includes “grey-box” algorithms that use more than just the matrix to solve certain classes of problems more efficiently than general-purpose libraries. This includes algorithms such as structured multigrid.
- **Suite of common iterative methods provides options for a spectrum of problems:** *hypre* provides several of the most commonly used Krylov-based iterative methods to be used in conjunction with its scalable preconditioners. This includes methods for nonsymmetric systems such as GMRES and methods for symmetric matrices such as Conjugate Gradient.
- **Intuitive grid-centric interfaces obviate need for complicated data structures and provide access to advanced solvers:** *hypre* has made a major step forward in usability from earlier generations of sparse linear solver libraries in that users do not have to learn complicated sparse matrix data structures. Instead, *hypre* does the work of building these data structures for the user through a variety of conceptual interfaces, each appropriate to

different classes of users. These include stencil-based structured/semi-structured interfaces most appropriate for finite-difference applications; a finite-element based unstructured interface; and a linear-algebra based interface. Each conceptual interface provides access to several solvers without the need to write new interface code.

- **User options accommodate beginners through experts:** *hypre* allows a spectrum of expertise to be applied by users. The beginning user can get up and running with a minimal amount of effort. More expert users can take further control of the solution process through various parameters.
- **Configuration options to suit your computing system:** *hypre* allows a simple and flexible installation on a wide variety of computing systems. Users can tailor the installation to match their computing system. Options include debug and optimized modes, the ability to change required libraries such as MPI and BLAS, a sequential mode, and modes enabling threads for certain solvers. On most systems, however, *hypre* can be built by simply typing `configure` followed by `make`, or by using CMake [8].
- **Interfaces in multiple languages provide greater flexibility for applications:** *hypre* is written in C (with the exception of the FEI interface, which is written in C++) and provides an interface for Fortran users.

## 1.2 Getting More Information

This user's manual consists of chapters describing each conceptual interface, a chapter detailing the various linear solver options available, and detailed installation information. In addition to this manual, a number of other information sources for *hypre* are available.

- **Reference Manual:** The reference manual comprehensively lists all of the interface and solver functions available in *hypre*. The reference manual is ideal for determining the various options available for a particular solver or for viewing the functions provided to describe a problem for a particular interface.
- **Example Problems:** A suite of example problems is provided with the *hypre* installation. These examples reside in the `examples` subdirectory and demonstrate various features of the *hypre* library. Associated documentation may be accessed by viewing the `README.html` file in that same directory.
- **Papers, Presentations, etc.:** Articles and presentations related to the *hypre* software library and the solvers available in the library are available from the *hypre* web page at <http://www.llnl.gov/CASC/hypre/>.
- **Mailing List:** The mailing list *hypre-announce* can be subscribed to through the *hypre* web page at <http://www.llnl.gov/CASC/hypre/>. The development team uses this list to announce new releases of *hypre*. It cannot be posted to by users.



## 1.3 How to get started

### 1.3.1 Installing *hypre*

As previously noted, on most systems *hypre* can be built by simply typing `configure` followed by `make` in the top-level source directory. Alternatively, the CMake system [8] can be used, and is the best approach for building *hypre* on Windows systems in particular. For more detailed instructions, read the `INSTALL` file provided with the *hypre* distribution or refer to the last chapter in this manual. Note the following requirements:

- To run in parallel, *hypre* requires an installation of MPI.
- Configuration of *hypre* with threads requires an implementation of OpenMP. Currently, only a subset of *hypre* is threaded.
- The *hypre* library currently does not directly support complex-valued systems.

### 1.3.2 Choosing a conceptual interface

An important decision to make before writing any code is to choose an appropriate conceptual interface. These conceptual interfaces are intended to represent the way that applications developers naturally think of their linear problem and to provide natural interfaces for them to pass the data that defines their linear system into *hypre*. Essentially, these conceptual interfaces can be considered convenient utilities for helping a user build a matrix data structure for *hypre* solvers and preconditioners. The top row of Figure 1.1 illustrates a number of conceptual interfaces. Generally, the conceptual interfaces are denoted by different types of computational grids, but other application features might also be used, such as geometrical information. For example, applications that use structured grids (such as in the left-most interface in the Figure 1.1) typically view their linear problems in terms of stencils and grids. On the other hand, applications that use unstructured grids and finite elements typically view their linear problems in terms of elements and element stiffness matrices. Finally, the right-most interface is the standard linear-algebraic (matrix rows/columns) way of viewing the linear problem.

The *hypre* library currently supports four conceptual interfaces, and typically the appropriate choice for a given problem is fairly obvious, e.g. a structured-grid interface is clearly inappropriate for an unstructured-grid application.

- **Structured-Grid System Interface (Struct):** This interface is appropriate for applications whose grids consist of unions of logically rectangular grids with a fixed stencil pattern of nonzeros at each grid point. This interface supports only a single unknown per grid point. See Chapter 2 for details.
- **Semi-Structured-Grid System Interface (SStruct):** This interface is appropriate for applications whose grids are mostly structured, but with some unstructured features. Examples include block-structured grids, composite grids in structured adaptive mesh refinement (AMR) applications, and overset grids. This interface supports multiple unknowns per cell. See Chapter 3 for details.

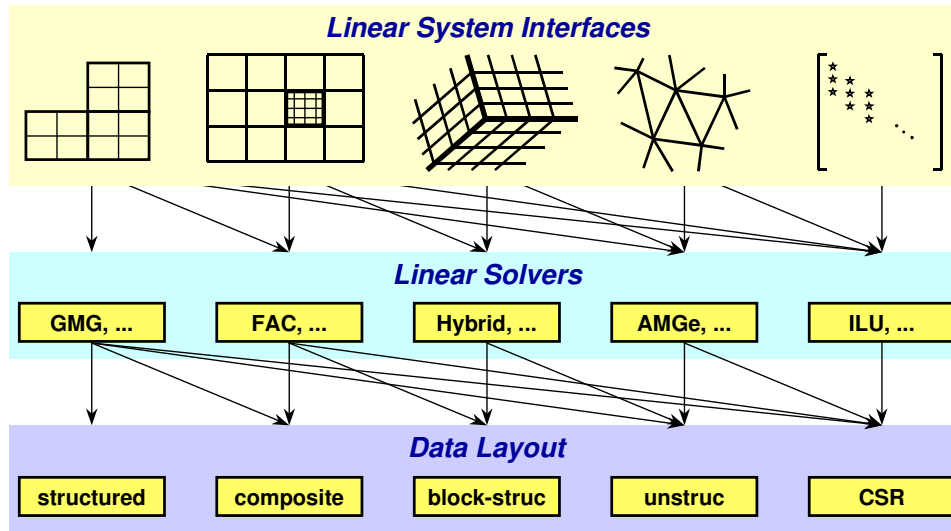

Figure 1.1: Graphic illustrating the notion of conceptual interfaces.

- **Finite Element Interface (FEI):** This is appropriate for users who form their linear systems from a finite element discretization. The interface mirrors typical finite element data structures, including element stiffness matrices. Though this interface is provided in *hypr*, its definition was determined elsewhere (please email to Alan Williams [william@sandia.gov](mailto:william@sandia.gov) for more information). See Chapter 4 for details.
- **Linear-Algebraic System Interface (IJ):** This is the traditional linear-algebraic interface. It can be used as a last resort by users for whom the other grid-based interfaces are not appropriate. It requires more work on the user's part, though still less than building parallel sparse data structures. General solvers and preconditioners are available through this interface, but not specialized solvers which need more information. Our experience is that users with legacy codes, in which they already have code for building matrices in particular formats, find the IJ interface relatively easy to use. See Chapter 5 for details.

Generally, a user should choose the most specific interface that matches their application, because this will allow them to use specialized and more efficient solvers and preconditioners without losing access to more general solvers. For example, the second row of Figure 1.1 is a set of linear solver algorithms. Each linear solver group requires different information from the user through the conceptual interfaces. So, the geometric multigrid algorithm (GMG) listed in the left-most box, for example, can only be used with the left-most conceptual interface. On the other hand, the ILU algorithm in the right-most box may be used with any conceptual interface. Matrix requirements for each solver and preconditioner are provided in Chapter 6 and in the *hypr* Reference Manual. Your desired solver strategy may influence your choice of conceptual interface. A typical user will select a single Krylov method and a single preconditioner to solve their system.

The third row of Figure 1.1 is a list of data layouts or matrix/vector storage schemes. The

relationship between linear solver and storage scheme is similar to that of the conceptual interface and linear solver. Note that some of the interfaces in *hypre* currently only support one matrix/vector storage scheme choice. The conceptual interface, the desired solvers and preconditioners, and the matrix storage class must all be compatible.

### 1.3.3 Writing your code

As discussed in the previous section, the following decisions should be made before writing any code:

1. Choose a conceptual interface.
2. Choose your desired solver strategy.
3. Look up matrix requirements for each solver and preconditioner.
4. Choose a matrix storage class that is compatible with your solvers and preconditioners and your conceptual interface.

Once the previous decisions have been made, it is time to code your application to call *hypre*. At this point, reviewing the previously mentioned example codes provided with the *hypre* library may prove very helpful. The example codes demonstrate the following general structure of the application calls to *hypre*:

1. **Build any necessary auxiliary structures for your chosen conceptual interface.** This includes, e.g., the grid and stencil structures if you are using the structured-grid interface.
2. **Build the matrix, solution vector, and right-hand-side vector through your chosen conceptual interface.** Each conceptual interface provides a series of calls for entering information about your problem into *hypre*.
3. **Build solvers and preconditioners and set solver parameters (optional).** Some parameters like convergence tolerance are the same across solvers, while others are solver specific.
4. **Call the solve function for the solver.**
5. **Retrieve desired information from solver.** Depending on your application, there may be different things you may want to do with the solution vector. Also, performance information such as number of iterations is typically available, though it may differ from solver to solver.

The subsequent chapters of this User's Manual provide the details needed to more fully understand the function of each conceptual interface and each solver. Remember that a comprehensive list of all available functions is provided in the *hypre* Reference Manual, and the provided example codes may prove helpful as templates for your specific application.



## Chapter 2

# Structured-Grid System Interface (Struct)

In order to get access to the most efficient and scalable solvers for scalar structured-grid applications, users should use the `Struct` interface described in this chapter. This interface will also provide access (this is not yet supported) to solvers in *hypre* that were designed for unstructured-grid applications and sparse linear systems in general. These additional solvers are usually provided via the unstructured-grid interface (FEI) or the linear-algebraic interface (IJ) described in Chapters 4 and 5.

Figure 2.1 gives an example of the type of grid currently supported by the `Struct` interface. The interface uses a finite-difference or finite-volume style, and currently supports only scalar PDEs (i.e., one unknown per gridpoint). There are four basic steps involved in setting up the linear system to be solved:

1. set up the grid,
2. set up the stencil,
3. set up the matrix,
4. set up the right-hand-side vector.

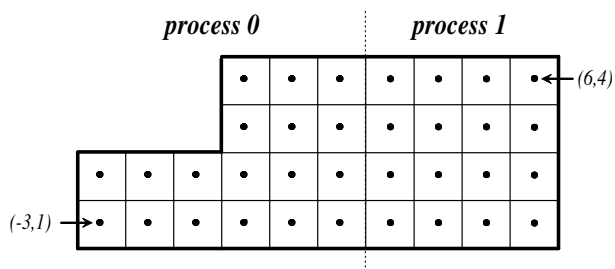

Figure 2.1: An example 2D structured grid, distributed across two processors.

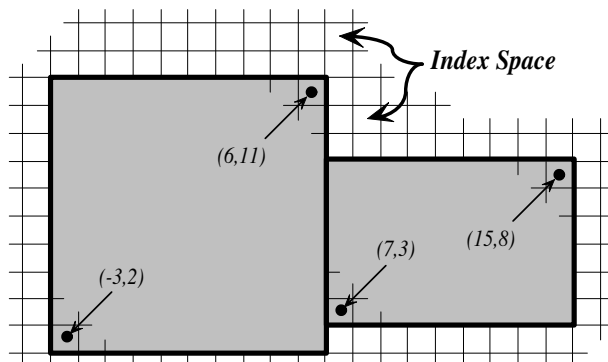

Figure 2.2: A box is a collection of abstract cell-centered indices, described by its minimum and maximum indices. Here, two boxes are illustrated.

To describe each of these steps in more detail, consider solving the 2D Laplacian problem

$$\begin{cases} \nabla^2 u = f, & \text{in the domain,} \\ u = 0, & \text{on the boundary.} \end{cases} \quad (2.1)$$

Assume (2.1) is discretized using standard 5-pt finite-volumes on the uniform grid pictured in 2.1, and assume that the problem data is distributed across two processes as depicted.

## 2.1 Setting Up the Struct Grid

The grid is described via a global *index space*, i.e., via integer singles in 1D, tuples in 2D, or triples in 3D (see Figure 2.2). The integers may have any value, negative or positive. The global indexes allow *hypr* to discern how data is related spatially, and how it is distributed across the parallel machine. The basic component of the grid is a *box*: a collection of abstract cell-centered indices in index space, described by its “lower” and “upper” corner indices. The scalar grid data is always associated with cell centers, unlike the more general `SStruct` interface which allows data to be associated with box indices in several different ways.

Each process describes that portion of the grid that it “owns”, one box at a time. For example, the global grid in Figure 2.1 can be described in terms of three boxes, two owned by process 0, and one owned by process 1. Figure 2.3 shows the code for setting up the grid on process 0 (the code for process 1 is similar). The `Create()` routine creates an empty 2D grid object that lives on the `MPI_COMM_WORLD` communicator. The `SetExtents()` routine adds a new box to the grid. The `Assemble()` routine is a collective call (i.e., must be called on all processes from a common synchronization point), and finalizes the grid assembly, making the grid “ready to use”.

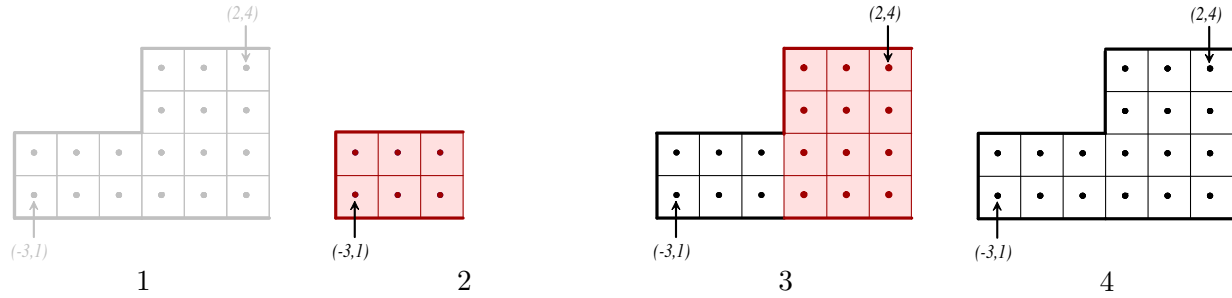

```

HYPRE_StructGrid grid;
int ndim          = 2;
int ilower[][2]  = {{-3,1}, {0,1}};
int iupper[][2]  = {{-1,2}, {2,4}};

/* Create the grid object */
1: HYPRE_StructGridCreate(MPI_COMM_WORLD, ndim, &grid);

/* Set grid extents for the first box */
2: HYPRE_StructGridSetExtents(grid, ilower[0], iupper[0]);

/* Set grid extents for the second box */
3: HYPRE_StructGridSetExtents(grid, ilower[1], iupper[1]);

/* Assemble the grid */
4: HYPRE_StructGridAssemble(grid);

```

Figure 2.3: Code on process 0 for setting up the grid in Figure 2.1.

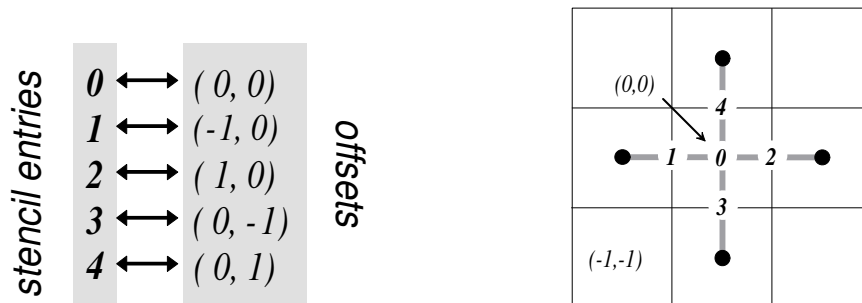

Figure 2.4: Representation of the 5-point discretization stencil for the example problem.

## 2.2 Setting Up the Struct Stencil

The geometry of the discretization stencil is described by an array of indexes, each representing a relative offset from any given gridpoint on the grid. For example, the geometry of the 5-pt stencil for the example problem being considered can be represented by the list of index offsets shown in Figure 2.4. Here, the  $(0,0)$  entry represents the “center” coefficient, and is the 0th stencil entry. The  $(0,-1)$  entry represents the “south” coefficient, and is the 3rd stencil entry. And so on.

On process 0 or 1, the code in Figure 2.5 will set up the stencil in Figure 2.4. The stencil must be the same on all processes. The `Create()` routine creates an empty 2D, 5-pt stencil object. The `SetElement()` routine defines the geometry of the stencil and assigns the stencil numbers for each of the stencil entries. None of the calls are collective calls.

## 2.3 Setting Up the Struct Matrix

The matrix is set up in terms of the grid and stencil objects described in Sections 2.1 and 2.2. The coefficients associated with each stencil entry will typically vary from gridpoint to gridpoint, but in the example problem being considered, they are as follows over the entire grid (except at boundaries; see below):

$$\begin{bmatrix} & -1 & \\ -1 & 4 & -1 \\ & -1 & \end{bmatrix}. \quad (2.2)$$

On process 0, the code in Figure 2.6 will set up matrix values associated with the center (entry 0) and south (entry 3) stencil entries as given by 2.2 and Figure 2.6 (boundaries are ignored here temporarily). The `Create()` routine creates an empty matrix object. The `Initialize()` routine indicates that the matrix coefficients (or values) are ready to be set. This routine may or may not involve the allocation of memory for the coefficient data, depending on the implementation. The optional `Set` routines mentioned later in this chapter and in the Reference Manual, should be called before this step. The `SetBoxValues()` routine sets the matrix coefficients for some set of stencil entries over the gridpoints in some box. Note that the box need not correspond to any of the boxes used to create the grid, but values should be set for all gridpoints that this process



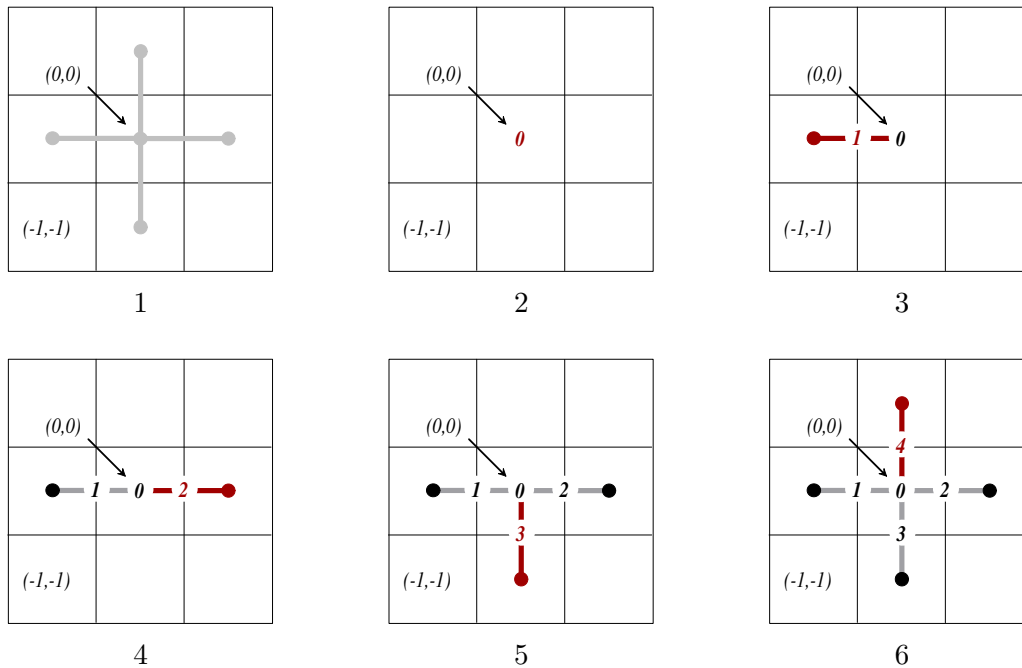

```

HYPRE_StructStencil stencil;
int ndim      = 2;
int size      = 5;
int entry;
int offsets[][2] = {{0,0}, {-1,0}, {1,0}, {0,-1}, {0,1}};

/* Create the stencil object */
1: HYPRE_StructStencilCreate(ndim, size, &stencil);

/* Set stencil entries */
for (entry = 0; entry < size; entry++)
{
2-6: HYPRE_StructStencilSetElement(stencil, entry, offsets[entry]);
}

/* Thats it! There is no assemble routine */

```

Figure 2.5: Code for setting up the stencil in Figure 2.4.

```
HYPRE_StructMatrix A;
double            values[36];
int               stencil_indices[2] = {0,3};
int               i;

HYPRE_StructMatrixCreate(MPI_COMM_WORLD, grid, stencil, &A);
HYPRE_StructMatrixInitialize(A);

for (i = 0; i < 36; i += 2)
{
    values[i]    = 4.0;
    values[i+1] = -1.0;
}

HYPRE_StructMatrixSetBoxValues(A, ilower[0], iupper[0], 2,
                               stencil_indices, values);
HYPRE_StructMatrixSetBoxValues(A, ilower[1], iupper[1], 2,
                               stencil_indices, values);

/* set boundary conditions */
...

HYPRE_StructMatrixAssemble(A);
```

Figure 2.6: Code for setting up matrix values associated with stencil entries 0 and 3 as given by 2.2 and Figure 2.4.

```

int  ilower[2] = {-3, 1};
int  iupper[2] = { 2, 1};

/* create matrix and set interior coefficients */
...

/* implement boundary conditions */
...

for (i = 0; i < 12; i++)
{
    values[i] = 0.0;
}

i = 3;
HYPRE_StructMatrixSetBoxValues(A, ilower, iupper, 1, &i, values);

/* complete implementation of boundary conditions */
...

```

Figure 2.7: Code for adjusting boundary conditions along the lower grid boundary in Figure 2.1.

“owns”. The `Assemble()` routine is a collective call, and finalizes the matrix assembly, making the matrix “ready to use”.

Matrix coefficients that reach outside of the boundary should be set to zero. For efficiency reasons, *hypre* does not do this automatically. The most natural time to insure this is when the boundary conditions are being set, and this is most naturally done after the coefficients on the grid’s interior have been set. For example, during the implementation of the Dirichlet boundary condition on the lower boundary of the grid in Figure 2.1, the “south” coefficient must be set to zero. To do this on process 0, the code in Figure 2.7 could be used:

## 2.4 Setting Up the Struct Right-Hand-Side Vector

The right-hand-side vector is set up similarly to the matrix set up described in Section 2.3 above. The main difference is that there is no stencil (note that a stencil currently does appear in the interface, but this will eventually be removed).

On process 0, the code in Figure 2.8 will set up the right-hand-side vector values. The `Create()` routine creates an empty vector object. The `Initialize()` routine indicates that the vector coefficients (or values) are ready to be set. This routine follows the same rules as its corresponding `Matrix` routine. The `SetBoxValues()` routine sets the vector coefficients over the gridpoints in some box, and again, follows the same rules as its corresponding `Matrix` routine. The `Assemble()`

```

HYPRE_StructVector  b;
double              values[18];
int                 i;

HYPRE_StructVectorCreate(MPI_COMM_WORLD, grid, &b);
HYPRE_StructVectorInitialize(b);

for (i = 0; i < 18; i++)
{
    values[i] = 0.0;
}

HYPRE_StructVectorSetBoxValues(b, ilower[0], iupper[0], values);
HYPRE_StructVectorSetBoxValues(b, ilower[1], iupper[1], values);

HYPRE_StructVectorAssemble(b);

```

Figure 2.8: Code for setting up right-hand-side vector values.

routine is a collective call, and finalizes the vector assembly, making the vector “ready to use”.

## 2.5 Symmetric Matrices

Some solvers and matrix storage schemes provide capabilities for significantly reducing memory usage when the coefficient matrix is symmetric. In this situation, each off-diagonal coefficient appears twice in the matrix, but only one copy needs to be stored. The `Struct` interface provides support for matrix and solver implementations that use symmetric storage via the `SetSymmetric()` routine.

To describe this in more detail, consider again the 5-pt finite-volume discretization of (2.1) on the grid pictured in Figure 2.1. Because the discretization is symmetric, only half of the off-diagonal coefficients need to be stored. To turn symmetric storage on, the following line of code needs to be inserted somewhere between the `Create()` and `Initialize()` calls.

```
HYPRE_StructMatrixSetSymmetric(A, 1);
```

The coefficients for the entire stencil can be passed in as before. Note that symmetric storage may or may not actually be used, depending on the underlying storage scheme. Currently in *hypre*, the `Struct` interface always uses symmetric storage.

To most efficiently utilize the `Struct` interface for symmetric matrices, notice that only half of the off-diagonal coefficients need to be set. To do this for the example being considered, we simply

need to redefine the 5-pt stencil of Section 2.2 to an “appropriate” 3-pt stencil, then set matrix coefficients (as in Section 2.3) for these three stencil elements *only*. For example, we could use the following stencil

$$\left[ \begin{array}{cc} (0, 1) & \\ (0, 0) & (1, 0) \end{array} \right]. \quad (2.3)$$

This 3-pt stencil provides enough information to recover the full 5-pt stencil geometry and associated matrix coefficients.



## Chapter 3

# Semi-Structured-Grid System Interface (SStruct)

The `SStruct` interface is appropriate for applications with grids that are mostly—but not entirely—structured, e.g. block-structured grids (see Figure 3.2), composite grids in structured adaptive mesh refinement (AMR) applications (see Figure 3.9), and overset grids. In addition, it supports more general PDEs than the `Struct` interface by allowing multiple variables (system PDEs) and multiple variable types (e.g. cell-centered, face-centered, etc.). The interface provides access to data structures and linear solvers in *hypr* that are designed for semi-structured grid problems, but also to the most general data structures and solvers.

The `SStruct` grid is composed out of a number of structured grid *parts*, where the physical inter-relationship between the parts is arbitrary. Each part is constructed out of two basic components: boxes (see Figure 2.2) and *variables*. Variables represent the actual unknown quantities in the grid, and are associated with the box indices in a variety of ways, depending on their types. In *hypr*, variables may be cell-centered, node-centered, face-centered, or edge-centered. Face-centered variables are split into x-face, y-face, and z-face, and edge-centered variables are split into x-edge, y-edge, and z-edge. See Figure 3.1 for an illustration in 2D.

The `SStruct` interface uses a *graph* to allow nearly arbitrary relationships between part data. The graph is constructed from stencils or finite element stiffness matrices plus some additional data-coupling information set by the `GraphAddEntries()` routine. Two other methods for relating part data are the `GridSetNeighborPart()` and `GridSetSharedPart()` routines, which are particularly well suited for block-structured grid problems. The latter is useful for finite element codes.

There are five basic steps involved in setting up the linear system to be solved:

1. set up the grid,
2. set up the stencils (if needed),
3. set up the graph,
4. set up the matrix,
5. set up the right-hand-side vector.

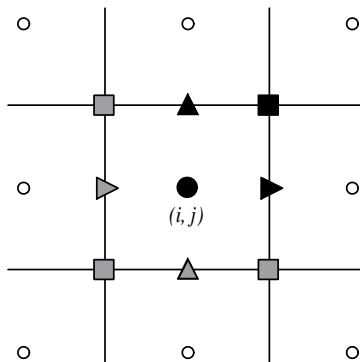

Figure 3.1: Grid variables in *hypre* are referenced by the abstract cell-centered index to the left and down in 2D (analogously in 3D). In the figure, index  $(i, j)$  is used to reference the variables in black. The variables in grey—although contained in the pictured cell—are not referenced by the  $(i, j)$  index.

### 3.1 Block-Structured Grids with Stencils

In this section, we describe how to use the `SStruct` interface to define block-structured grid problems. We do this primarily by example, paying particular attention to the construction of stencils and the use of the `GridSetNeighborPart()` interface routine.

Consider the solution of the diffusion equation

$$-\nabla \cdot (D\nabla u) + \sigma u = f \quad (3.1)$$

on the block-structured grid in Figure 3.2, where  $D$  is a scalar diffusion coefficient, and  $\sigma \geq 0$ . The discretization [29] introduces three different types of variables: cell-centered,  $x$ -face, and  $y$ -face. The three discretization stencils that couple these variables are also given in the figure. The information in this figure is essentially all that is needed to describe the nonzero structure of the linear system we wish to solve.

The grid in Figure 3.2 is defined in terms of five separate logically-rectangular parts as shown in Figure 3.3, and each part is given a unique label between 0 and 4. Each part consists of a single box with lower index  $(1, 1)$  and upper index  $(4, 4)$  (see Section 2.1), and the grid data is distributed on five processes such that data associated with part  $p$  lives on process  $p$ . Note that in general, parts may be composed out of arbitrary unions of boxes, and indices may consist of non-positive integers (see Figure 2.2). Also note that the `SStruct` interface expects a domain-based data distribution by boxes, but the actual distribution is determined by the user and simply described (in parallel) through the interface.

As with the `Struct` interface, each process describes that portion of the grid that it “owns”, one box at a time. Figure 3.4 shows the code for setting up the grid on process 3 (the code for the other processes is similar). The “icons” at the top of the figure illustrate the result of the numbered lines of code. Process 3 needs to describe the data pictured in the bottom-right of the figure. That is, it needs to describe part 3 plus some additional neighbor information that ties part 3 together



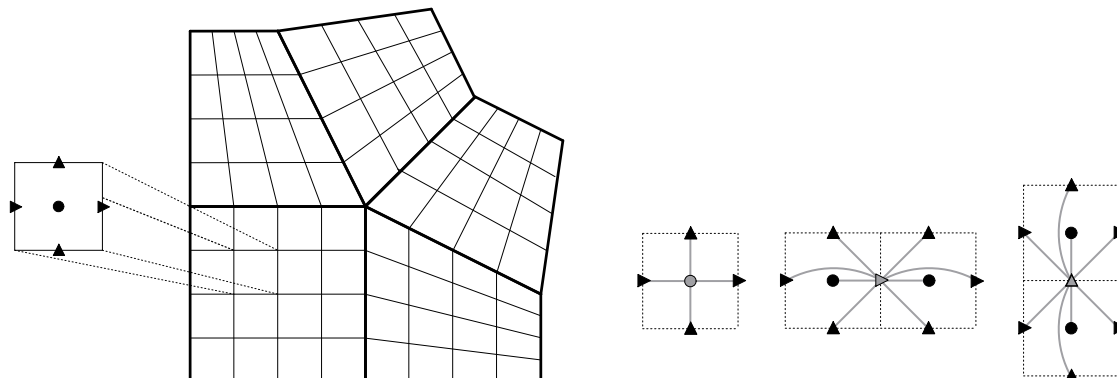

Figure 3.2: Example of a block-structured grid with five logically-rectangular blocks and three variables types: cell-centered,  $x$ -face, and  $y$ -face. Discretization stencils for the cell-centered (left),  $x$ -face (middle), and  $y$ -face (right) variables are also pictured.

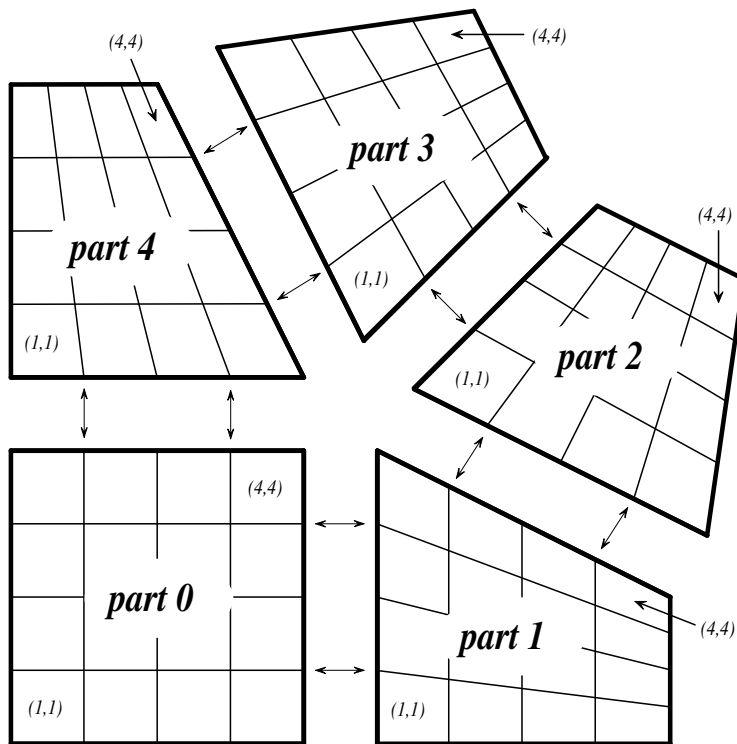
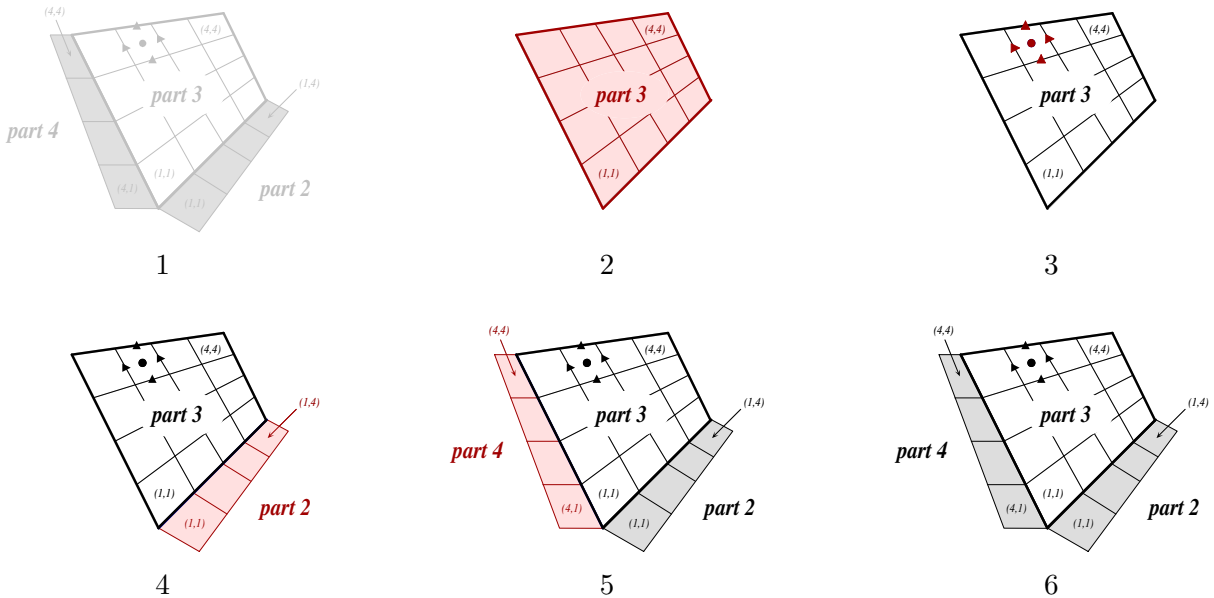

Figure 3.3: One possible labeling of the grid in Figure 3.2.



```

HYPRE_SStructGrid grid;
int ndim = 2, nparts = 5, nvars = 3, part = 3;
int extents[] [2] = {{1,1}, {4,4}};
int vartypes[] = {HYPRE_SSTRUCT_VARIABLE_CELL,
                  HYPRE_SSTRUCT_VARIABLE_XFACE,
                  HYPRE_SSTRUCT_VARIABLE_YFACE};

int nb2_n_part      = 2,          nb4_n_part      = 4;
int nb2_exts[] [2] = {{1,0}, {4,0}}, nb4_exts[] [2] = {{0,1}, {0,4}};
int nb2_n_exts[] [2] = {{1,1}, {1,4}}, nb4_n_exts[] [2] = {{4,1}, {4,4}};
int nb2_map[2]      = {1,0},      nb4_map[2]      = {0,1};
int nb2_dir[2]      = {1,-1},     nb4_dir[2]     = {1,1};

```

```

1: HYPRE_SStructGridCreate(MPI_COMM_WORLD, ndim, nparts, &grid);

/* Set grid extents and grid variables for part 3 */
2: HYPRE_SStructGridSetExtents(grid, part, extents[0], extents[1]);
3: HYPRE_SStructGridSetVariables(grid, part, nvars, vartypes);

/* Set spatial relationship between parts 3 and 2, then parts 3 and 4 */
4: HYPRE_SStructGridSetNeighborPart(grid, part, nb2_exts[0], nb2_exts[1],
    nb2_n_part, nb2_n_exts[0], nb2_n_exts[1], nb2_map, nb2_dir);
5: HYPRE_SStructGridSetNeighborPart(grid, part, nb4_exts[0], nb4_exts[1],
    nb4_n_part, nb4_n_exts[0], nb4_n_exts[1], nb4_map, nb4_dir);

6: HYPRE_SStructGridAssemble(grid);

```

Figure 3.4: Code on process 3 for setting up the grid in Figure 3.2.

with the rest of the grid. The `Create()` routine creates an empty 2D grid object with five parts that lives on the `MPI_COMM_WORLD` communicator. The `SetExtents()` routine adds a new box to the grid. The `SetVariables()` routine associates three variables of type cell-centered,  $x$ -face, and  $y$ -face with part 3.

At this stage, the description of the data on part 3 is complete. However, the spatial relationship between this data and the data on neighboring parts is not yet defined. To do this, we need to relate the index space for part 3 with the index spaces of parts 2 and 4. More specifically, we need to tell the interface that the two grey boxes neighboring part 3 in the bottom-right of Figure 3.4 also correspond to boxes on parts 2 and 4. This is done through the two calls to the `SetNeighborPart()` routine. We discuss only the first call, which describes the grey box on the right of the figure. Note that this grey box lives outside of the box extents for the grid on part 3, but it can still be described using the index-space for part 3 (recall Figure 2.2). That is, the grey box has extents  $(1, 0)$  and  $(4, 0)$  on part 3's index-space, which is outside of part 3's grid. The arguments for the `SetNeighborPart()` call are simply the lower and upper indices on part 3 and the corresponding indices on part 2. The final two arguments to the routine indicate that the positive  $x$ -direction on part 3 (i.e., the  $i$  component of the tuple  $(i, j)$ ) corresponds to the positive  $y$ -direction on part 2 and that the positive  $y$ -direction on part 3 corresponds to the positive  $x$ -direction on part 2.

The `Assemble()` routine is a collective call (i.e., must be called on all processes from a common synchronization point), and finalizes the grid assembly, making the grid “ready to use”.

With the neighbor information, it is now possible to determine where off-part stencil entries couple. Take, for example, any shared part boundary such as the boundary between parts 2 and 3. Along these boundaries, some stencil entries reach outside of the part. If no neighbor information is given, these entries are effectively zeroed out, i.e., they don't participate in the discretization. However, with the additional neighbor information, when a stencil entry reaches into a neighbor box it is then coupled to the part described by that neighbor box information.

Another important consequence of the use of the `SetNeighborPart()` routine is that it can declare variables on different parts as being the same. For example, the face variables on the boundary of parts 2 and 3 are recognized as being shared by both parts (prior to the `SetNeighborPart()` call, there were two distinct sets of variables). Note also that these variables are of different types on the two parts; on part 2 they are  $x$ -face variables, but on part 3 they are  $y$ -face variables.

For brevity, we consider only the description of the  $y$ -face stencil in Figure 3.2, i.e. the third stencil in the figure. To do this, the stencil entries are assigned unique labels between 0 and 8 and their “offsets” are described relative to the “center” of the stencil. This process is illustrated in Figure 3.5. Nine calls are made to the routine `HYPRE_SStructStencilSetEntry()`. As an example, the call that describes stencil entry 5 in the figure is given the entry number 5, the offset  $(-1, 0)$ , and the identifier for the  $x$ -face variable (the variable to which this entry couples). Recall from Figure 3.1 the convention used for referencing variables of different types. The geometry description uses the same convention, but with indices numbered relative to the referencing index  $(0, 0)$  for the stencil's center. Figure 3.6 shows the code for setting up the graph .

With the above, we now have a complete description of the nonzero structure for the matrix. The matrix coefficients are then easily set in a manner similar to what is described in Section 2.3 using routines `MatrixSetValues()` and `MatrixSetBoxValues()` in the `SStruct` interface. As before,

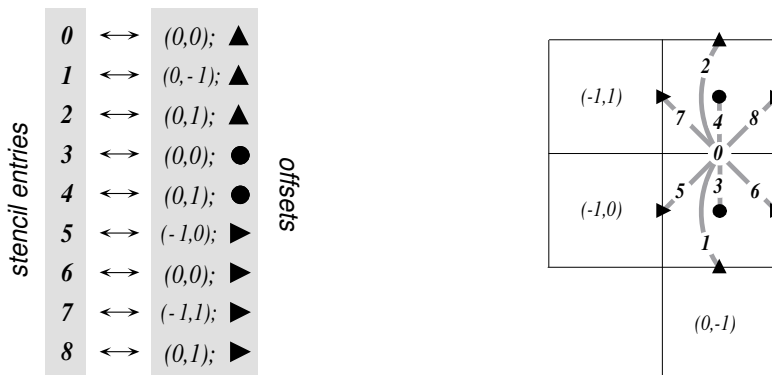
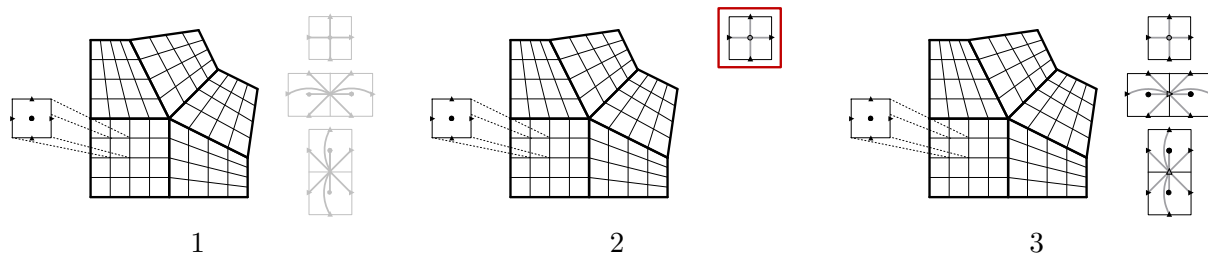
Figure 3.5: Assignment of labels and geometries to the  $y$ -face stencil in Figure 3.2.

```

HYPRE_SStructGraph graph;
HYPRE_SStructStencil c_stencil, x_stencil, y_stencil;
int c_var = 0, x_var = 1, y_var = 2;
int part;

1: HYPRE_SStructGraphCreate(MPI_COMM_WORLD, grid, &graph);

/* Set the cell-centered, x-face, and y-face stencils for each part */
for (part = 0; part < 5; part++)
{
2:   HYPRE_SStructGraphSetStencil(graph, part, c_var, c_stencil);
   HYPRE_SStructGraphSetStencil(graph, part, x_var, x_stencil);
   HYPRE_SStructGraphSetStencil(graph, part, y_var, y_stencil);
}

3: HYPRE_SStructGraphAssemble(graph);

```

Figure 3.6: Code on process 3 for setting up the graph for Figure 3.2.

there are also `AddTo` variants of these routines. Likewise, setting up the right-hand-side is similar to what is described in Section 2.4. See the *hypr* reference manual for details.

An alternative approach for describing the above problem through the interface is to use the `GraphAddEntries()` routine instead of the `GridSetNeighborPart()` routine. In this approach, the five parts would be explicitly “sewn” together by adding non-stencil couplings to the matrix graph. The main downside to this approach for block-structured grid problems is that variables along block boundaries are no longer considered to be the same variables on the corresponding parts that share these boundaries. For example, any face variable along the boundary between parts 2 and 3 in Figure 3.2 would represent two different variables that live on different parts. To “sew” the parts together correctly, we would need to explicitly select one of these variables as the representative that participates in the discretization, and make the other variable a dummy variable that is decoupled from the discretization by zeroing out appropriate entries in the matrix. All of these complications are avoided by using the `GridSetNeighborPart()` for this example.

## 3.2 Block-Structured Grids with Finite Elements

In this section, we describe how to use the `SStruct` interface to define block-structured grid problems with finite elements. We again do this by example, paying particular attention to the use of the FEM interface routines and the `GridSetSharedPart()` routine. See example code `ex14.c` for a complete implementation.

Consider a nodal finite element (FEM) discretization of the Laplace equation on the star-shaped grid in Figure 3.7. The local FEM stiffness matrix in the figure describes the coupling between the grid variables. Although we could still describe this problem using stencils as in Section 3.1, an FEM-based approach (available in *hypr* version 2.6.0b and later) is a more natural alternative.

The grid in Figure 3.7 is defined in terms of six separate logically-rectangular parts, and each part is given a unique label between 0 and 5. Each part consists of a single box with lower index (1,1) and upper index (9,9), and the grid data is distributed on six processes such that data associated with part  $p$  lives on process  $p$ .

As in Section 3.1, each process describes that portion of the grid that it “owns”, one box at a time. Figure 3.8 shows the code for setting up the grid on process 0 (the code for the other processes is similar). The “icons” at the top of the figure illustrate the result of the numbered lines of code. Process 0 needs to describe the data pictured in the bottom-right of the figure. That is, it needs to describe part 0 plus some additional information about shared data with other parts on the grid. The `SetFEMOrdering()` routine sets the ordering of the unknowns in an element (an element is always a grid cell in *hypr*). This determines the ordering of the data passed into the routines `MatrixAddFEMValues()` and `VectorAddFEMValues()` discussed later.

At this point, the layout of the data on part 0 is complete, but there is no relationship to the rest of the grid. To couple the parts, we need to tell *hypr* that some of the boundary variables on part 0 are shared with other parts, i.e., they are the same as some of the variables on other parts. This is done through five calls to the `SetSharedPart()` routine. Only the first call is shown in the figure; the other four calls are similar. The arguments to this routine are the same as `SetNeighborPart()` with the addition of two new offset arguments, named `offset` and `s_offset` in the figure. Each

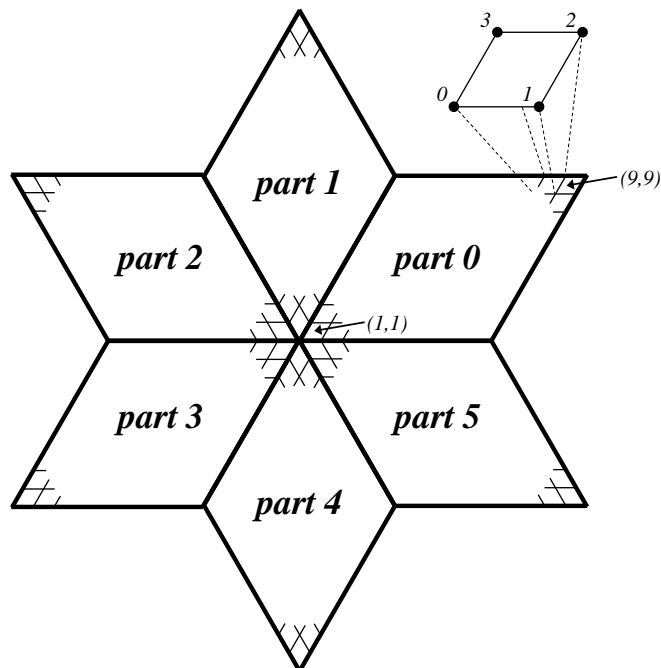

$$\begin{array}{c}
 \begin{array}{cccc}
 & 0 & 1 & 2 & 3 \\
 0 & \left( \begin{array}{cccc}
 4-k & -1 & -2+k & -1 \\
 -1 & 4+k & -1 & -2-k \\
 -2+k & -1 & 4-k & -1 \\
 -1 & -2-k & -1 & 4+k
 \end{array} \right) \\
 1 \\
 2 \\
 3
 \end{array} \alpha \\
 \alpha = (6 \sin(\gamma))^{-1}, \quad k = 3 \cos(\gamma), \quad \gamma = \pi/3
 \end{array}$$

Figure 3.7: Example of a star-shaped grid with six logically-rectangular blocks and one nodal variable. Each block has an angle at the origin given by  $\gamma = \pi/3$ . The finite element stiffness matrix (right) is given in terms of the pictured variable ordering (left).

offset represents a pointer from the cell center to one of the following: all variables in the cell (no nonzeros in offset); all variables on a face (only 1 nonzero); all variables on an edge (2 nonzeros); all variables at a point (3 nonzeros). The two offsets must be consistent with each other.

The graph is set up similarly to Figure 3.6, except that the stencil calls are replaced by calls to `GraphSetFEM()`. The nonzero pattern of the stiffness matrix can also be set by calling the optional routine `GraphSetFEMSparsity()`.

Matrix and vector values are set one element at a time. For the example in this section, calls on part 0 would have the following form:

```

int part = 0;
int index[2] = {i,j};
double m_values[16] = {...};
double v_values[4] = {...};

HYPRE_SStructMatrixAddFEMValues(A, part, index, m_values);
HYPRE_SStructVectorAddFEMValues(v, part, index, v_values);

```

Here, `m_values` contains local stiffness matrix values and `v_values` contains local variable values. The global matrix and vector are assembled internally by `hypre`, using the shared variables to couple the parts.

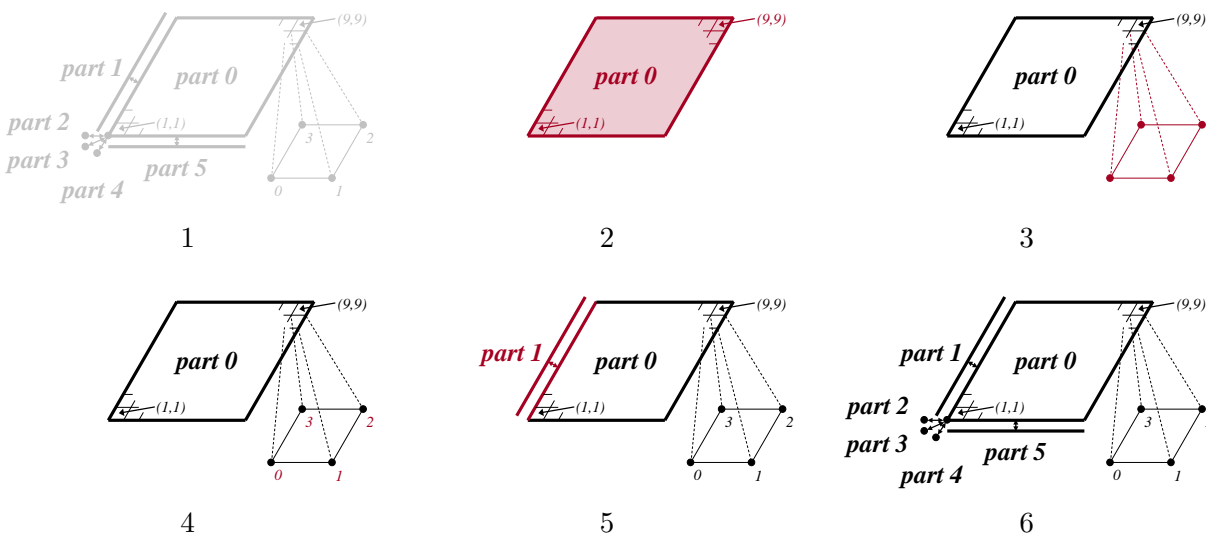

```

HYPRE_SStructGrid grid;
int ndim = 2, nparts = 6, nvars = 1, part = 0;
int ilower[2] = {1,1}, iupper[2] = {9,9};
int vartypes[] = {HYPRE_SSTRUCT_VARIABLE_NODE};
int ordering[12] = {0,-1,-1, 0,+1,-1, 0,+1,+1, 0,-1,+1};

int s_part = 2;
int ilo[2] = {1,1}, iup[2] = {1,9}, offset[2] = {-1,0};
int s_ilo[2] = {1,1}, s_iup[2] = {9,1}, s_offset[2] = {0,-1};
int map[2] = {1,0};
int dir[2] = {-1,1};

```

```

1: HYPRE_SStructGridCreate(MPI_COMM_WORLD, ndim, nparts, &grid);

/* Set grid extents, grid variables, and FEM ordering for part 0 */
2: HYPRE_SStructGridSetExtents(grid, part, ilower, iupper);
3: HYPRE_SStructGridSetVariables(grid, part, nvars, vartypes);
4: HYPRE_SStructGridSetFEMOrdering(grid, part, ordering);

/* Set shared variables for parts 0 and 1 (0 and 2/3/4/5 not shown) */
5: HYPRE_SStructGridSetSharedPart(grid, part, ilo, iup, offset,
    s_part, s_ilo, s_iup, s_offset, map, dir);

6: HYPRE_SStructGridAssemble(grid);

```

Figure 3.8: Code on process 0 for setting up the grid in Figure 3.7.

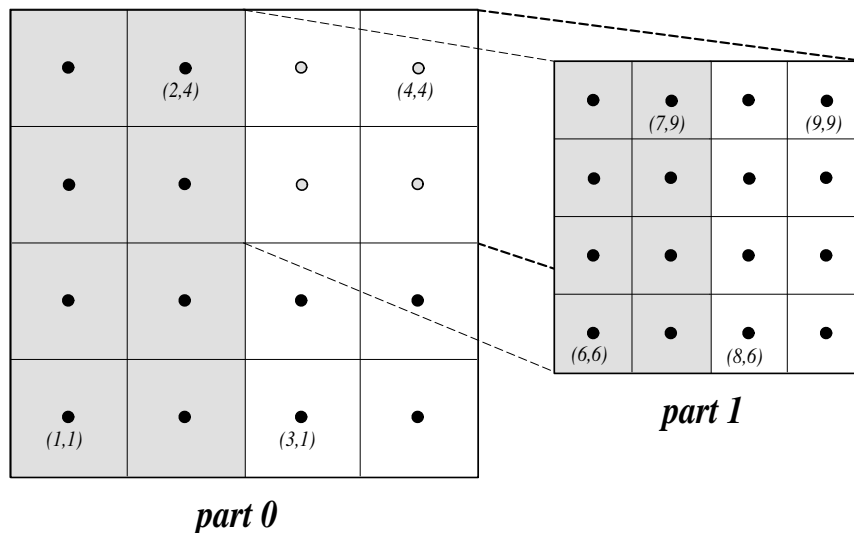

Figure 3.9: Structured AMR grid example. Shaded regions correspond to process 0, unshaded to process 1. The grey dots are dummy variables.

### 3.3 Structured Adaptive Mesh Refinement

We now briefly discuss how to use the `SSTRUCT` interface in a structured AMR application. Consider Poisson’s equation on the simple cell-centered example grid illustrated in Figure 3.9. For structured AMR applications, each refinement level should be defined as a unique part. There are two parts in this example: *part 0* is the global coarse grid and *part 1* is the single refinement patch. Note that the coarse unknowns underneath the refinement patch (gray dots in Figure 3.9) are not real physical unknowns; the solution in this region is given by the values on the refinement patch. In setting up the composite grid matrix [28] for *hypr* the equations for these “dummy” unknowns should be uncoupled from the other unknowns (this can easily be done by setting all off-diagonal couplings to zero in this region).

In the example, parts are distributed across the same two processes with process 0 having the “left” half of both parts. The composite grid is then set up part-by-part by making calls to `GridSetExtents()` just as was done in Section 3.1 and Figure 3.4 (no `SetNeighborPart` calls are made in this example). Note that in the interface there is no required rule relating the indexing on the refinement patch to that on the global coarse grid; they are separate parts and thus each has its own index space. In this example, we have chosen the indexing such that refinement cell  $(2i, 2j)$  lies in the lower left quadrant of coarse cell  $(i, j)$ . Then the stencil is set up. In this example we are using a finite volume approach resulting in the standard 5-point stencil in Figure 2.5 in both parts.

The grid and stencil are used to define all intra-part coupling in the graph, the non-zero pattern of the composite grid matrix. The inter-part coupling at the coarse-fine interface is described by `GraphAddEntries()` calls. This coupling in the composite grid matrix is typically the composition



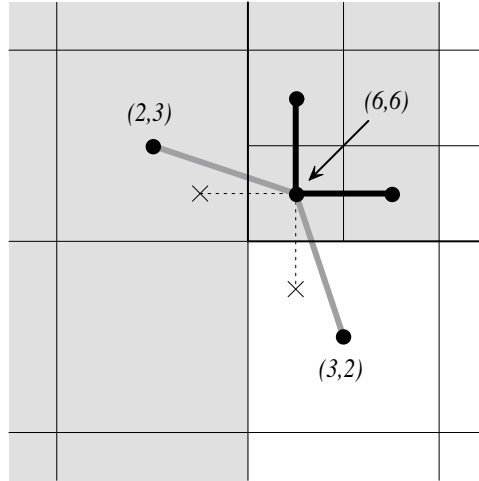

Figure 3.10: Coupling for equation at corner of refinement patch. Black lines (solid and broken) are stencil couplings. Gray lines are non-stencil couplings.

of an interpolation rule and a discretization formula. In this example, we use a simple piecewise constant interpolation, i.e. the solution value in a coarse cell is equal to the solution value at the cell center. Then the flux across a portion of the coarse-fine interface is approximated by a difference of the solution values on each side. As an example, consider approximating the flux across the left interface of cell (6,6) in Figure 3.10. Let  $h$  be the coarse grid mesh size, and consider a local coordinate system with the origin at the center of cell (6,6). We approximate the flux as follows

$$\begin{aligned} \int_{-h/4}^{h/4} u_x(-h/4, s) ds &\approx \frac{h}{2} u_x(-h/4, 0) \approx \frac{h}{2} \frac{u(0, 0) - u(-3h/4, 0)}{3h/4} \\ &\approx \frac{2}{3} (u_{6,6} - u_{2,3}). \end{aligned} \quad (3.2)$$

The first approximation uses the midpoint rule for the edge integral, the second uses a finite difference formula for the derivative, and the third the piecewise constant interpolation to the solution in the coarse cell. This means that the equation for the variable at cell (6,6) involves not only the stencil couplings to (6,7) and (7,6) on part 1 but also non-stencil couplings to (2,3) and (3,2) on part 0. These non-stencil couplings are described by `GraphAddEntries()` calls. The syntax for this call is simply the part and index for both the variable whose equation is being defined and the variable to which it couples. After these calls, the non-zero pattern of the matrix (and the graph) is complete. Note that the “west” and “south” stencil couplings simply “drop off” the part, and are effectively zeroed out (currently, this is only supported for the `HYPRE_PARCSR` object type, and these values must be manually zeroed out for other object types; see `MatrixSetObjectType()` in the reference manual).

The remaining step is to define the actual numerical values for the composite grid matrix. This can be done by either `MatrixSetValues()` calls to set entries in a single equation, or by

`MatrixSetBoxValues()` calls to set entries for a box of equations in a single call. The syntax for the `MatrixSetValues()` call is a part and index for the variable whose equation is being set and an array of entry numbers identifying which entries in that equation are being set. The entry numbers may correspond to stencil entries or non-stencil entries.

## Chapter 4

# Finite Element Interface

### 4.1 Introduction

Many application codes use unstructured finite element meshes. This section describes an interface for finite element problems, called the FEI, which is supported in *hypre*.

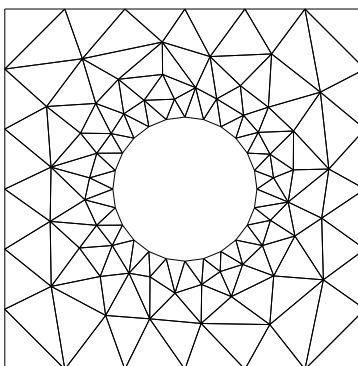

Figure 4.1: Example of an unstructured mesh.

FEI refers to a specific interface for black-box finite element solvers, originally developed in Sandia National Lab, see [11]. It differs from the rest of the conceptual interfaces in *hypre* in two important aspects: it is written in C++, and it does not separate the construction of the linear system matrix from the solution process. A complete description of Sandia's FEI implementation can be obtained by contacting Alan Williams at Sandia ([william@sandia.gov](mailto:william@sandia.gov)). A simplified version of the FEI has been implemented at LLNL and is included in *hypre*. More details about this implementation can be found in the header files of the `FEI_mv/fei-base` and `FEI_mv/fei-hypre` directories.

## 4.2 A Brief Description of the Finite Element Interface

Typically, finite element codes contain data structures storing element connectivities, element stiffness matrices, element loads, boundary conditions, nodal coordinates, etc. One of the purposes of the FEI is to assemble the global linear system in parallel based on such local element data. We illustrate this in the rest of the section and refer to example 10 (in the `examples` directory) for more implementation details.

In *hypr*, one creates an instance of the FEI as follows:

```
LLNL_FEI_Impl *feiPtr = new LLNL_FEI_Impl(mpiComm);
```

Here `mpiComm` is an MPI communicator (e.g. `MPI_COMM_WORLD`). If Sandia's FEI package is to be used, one needs to define a *hypr* solver object first:

```
LinearSystemCore *solver = HYPRE_base_create(mpiComm);
FEI_Implementation *feiPtr = FEI_Implementation(solver,mpiComm,rank);
```

where `rank` is the number of the master processor (used only to identify which processor will produce the screen outputs). The `LinearSystemCore` class is the part of the FEI which interfaces with the linear solver library. It will be discussed later in Sections 6.16 and 7.7.

Local finite element information is passed to the FEI using several methods of the `feiPtr` object. The first entity to be submitted is the *field* information. A *field* has an identifier called `fieldID` and a rank or `fieldSize` (number of degree of freedom). For example, a discretization of the Navier Stokes equations in 3D can consist of velocity vector having 3 degrees of freedom in every node (vertex) of the mesh and a scalar pressure variable, which is constant over each element. If these are the only variables, and if we assign `fieldIDs` 7 and 8 to them, respectively, then the finite element field information can be set up by

```
nFields    = 2;                /* number of unknown fields */
fieldID    = new int[nFields]; /* field identifiers */
fieldSize  = new int[nFields]; /* vector dimension of each field */

/* velocity (a 3D vector) */
fieldID[0]  = 7;
fieldSize[0] = 3;

/* pressure (a scalar function) */
fieldID[1]  = 8;
fieldSize[1] = 1;

feiPtr -> initFields(nFields, fieldSize, fieldID);
```

Once the field information has been established, we are ready to initialize an element block. An element block is characterized by the block identifier, the number of elements, the number of nodes per element, the nodal fields and the element fields (fields that have been defined previously). Suppose we use 1000 hexahedral elements in the element block 0, the setup consists of

```

elemBlkID = 0;      /* identifier for a block of elements */
nElems    = 1000; /* number of elements in the block */
elemNNodes = 8;    /* number of nodes per element */

/* nodal-based field for the velocity */
nodeNFields = 1;
nodeFieldIDs = new[nodeNFields];
nodeFieldIDs[0] = fieldID[0];

/* element-based field for the pressure */
elemNFields = 1;
elemFieldIDs = new[elemNFields];
elemFieldIDs[0] = fieldID[1];

feiPtr -> initElemBlock(elemBlkID, nElems, elemNNodes, nodeNFields,
                       nodeFieldIDs, elemNFields, elemFieldIDs, 0);

```

The last argument above specifies how the dependent variables are arranged in the element matrices. A value of 0 indicates that each variable is to be arranged in a separate block (as opposed to interleaving).

In a parallel environment, each processor has one or more element blocks. Unless the element blocks are all disjoint, some of them share a common set of nodes on the subdomain boundaries. To facilitate setting up interprocessor communications, shared nodes between subdomains on different processors are to be identified and sent to the FEI. Hence, each node in the whole domain is assigned a unique global identifier. The shared node list on each processor contains a subset of the global node list corresponding to the local nodes that are shared with the other processors. The syntax for setting up the shared nodes is

```

feiPtr -> initSharedNodes(nShared, sharedIDs, sharedLengs, sharedProcs);

```

This completes the initialization phase, and a completion signal is sent to the FEI via

```

feiPtr -> initComplete();

```

Next, we begin the *load* phase. The first entity for loading is the nodal boundary conditions. Here we need to specify the number of boundary equations and the boundary values given by **alpha**, **beta**, and **gamma**. Depending on whether the boundary conditions are Dirichlet, Neumann, or mixed, the three values should be passed into the FEI accordingly.

```

feiPtr -> loadNodeBCs(nBCs, BCEqn, fieldID, alpha, beta, gamma);

```

The element stiffness matrices are to be loaded in the next step. We need to specify the element number  $i$ , the element block to which element  $i$  belongs, the element connectivity information, the element load, and the element matrix format. The element connectivity specifies a set of 8 node global IDs (for hexahedral elements), and the element load is the load or force for each degree of freedom. The element format specifies how the equations are arranged (similar to the interleaving scheme mentioned above). The calling sequence for loading element stiffness matrices is

```
for (i = 0; i < nElems; i++)  
    feiPtr -> sumInElem(elemBlkID, elemID, elemConn[i], elemStiff[i],  
                        elemLoads[i], elemFormat);
```

To complete the assembling of the global stiffness matrix and the corresponding right hand side, a signal is sent to the FEI via

```
feiPtr -> loadComplete();
```

## Chapter 5

# Linear-Algebraic System Interface (IJ)

The IJ interface described in this chapter is the lowest common denominator for specifying linear systems in *hypre*. This interface provides access to general sparse-matrix solvers in *hypre*, not to the specialized solvers that require more problem information.

### 5.1 IJ Matrix Interface

As with the other interfaces in *hypre*, the IJ interface expects to get data in distributed form because this is the only scalable approach for assembling matrices on thousands of processes. Matrices are assumed to be distributed by blocks of rows as follows:

$$\begin{bmatrix} A_0 \\ A_1 \\ \vdots \\ A_{P-1} \end{bmatrix} \quad (5.1)$$

In the above example, the matrix is distributed across the  $P$  processes,  $0, 1, \dots, P - 1$  by blocks of rows. Each submatrix  $A_p$  is “owned” by a single process and its first and last row numbers are given by the global indices `ilower` and `iupper` in the `Create()` call below.

The following example code illustrates the basic usage of the IJ interface for building matrices:

```
MPI_Comm      comm;
HYPRE_IJMatrix ij_matrix;
HYPRE_ParCSRMatrix parcsr_matrix;
int           ilower, iupper;
int           jlower, jupper;
int           nrows;
```

```

int          *ncols;
int          *rows;
int          *cols;
double      *values;

HYPRE_IJMatrixCreate(comm, ilower, iupper, jlower, jupper, &ij_matrix);
HYPRE_IJMatrixSetObjectType(ij_matrix, HYPRE_PARCSR);
HYPRE_IJMatrixInitialize(ij_matrix);

/* set matrix coefficients */
HYPRE_IJMatrixSetValues(ij_matrix, nrows, ncols, rows, cols, values);
...
/* add-to matrix coefficients, if desired */
HYPRE_IJMatrixAddToValues(ij_matrix, nrows, ncols, rows, cols, values);
...

HYPRE_IJMatrixAssemble(ij_matrix);
HYPRE_IJMatrixGetObject(ij_matrix, (void **) &parcsr_matrix);

```

The `Create()` routine creates an empty matrix object that lives on the `comm` communicator. This is a collective call (i.e., must be called on all processes from a common synchronization point), with each process passing its own row extents, `ilower` and `iupper`. The row partitioning must be contiguous, i.e., `iupper` for process `i` must equal `ilower`−1 for process `i+1`. Note that this allows matrices to have 0- or 1-based indexing. The parameters `jlower` and `jupper` define a column partitioning, and should match `ilower` and `iupper` when solving square linear systems. See the Reference Manual for more information.

The `SetObjectType()` routine sets the underlying matrix object type to `HYPRE_PARCSR` (this is the only object type currently supported). The `Initialize()` routine indicates that the matrix coefficients (or values) are ready to be set. This routine may or may not involve the allocation of memory for the coefficient data, depending on the implementation. The optional `SetRowSizes()` and `SetDiagOffdSizes()` routines mentioned later in this chapter and in the Reference Manual, should be called before this step.

The `SetValues()` routine sets matrix values for some number of rows (`nrows`) and some number of columns in each row (`ncols`). The actual row and column numbers of the matrix `values` to be set are given by `rows` and `cols`. The coefficients can be modified with the `AddToValues()` routine. If `AddToValues()` is used to add to a value that previously didn't exist, it will set this value. Note that while `AddToValues()` will add to values on other processors, `SetValues()` does not set values on other processors. Instead if a user calls `SetValues()` on processor `i` to set a matrix coefficient belonging to processor `j`, processor `i` will erase all previous occurrences of this matrix coefficient, so they will not contribute to this coefficient on processor `j`. The actual coefficient has to be set on processor `j`.

The `Assemble()` routine is a collective call, and finalizes the matrix assembly, making the



matrix “ready to use”. The `GetObject()` routine retrieves the built matrix object so that it can be passed on to *hypr*e solvers that use the `ParCSR` internal storage format. Note that this is not an expensive routine; the matrix already exists in `ParCSR` storage format, and the routine simply returns a “handle” or pointer to it. Although we currently only support one underlying data storage format, in the future several different formats may be supported.

One can preset the row sizes of the matrix in order to reduce the execution time for the matrix specification. One can specify the total number of coefficients for each row, the number of coefficients in the row that couple the diagonal unknown to (`Diag`) unknowns in the same processor domain, and the number of coefficients in the row that couple the diagonal unknown to (`Offd`) unknowns in other processor domains:

```
HYPRE_IJMatrixSetRowSizes(ij_matrix, sizes);
HYPRE_IJMatrixSetDiagOffdSizes(matrix, diag_sizes, offdiag_sizes);
```

Once the matrix has been assembled, the sparsity pattern cannot be altered without completely destroying the matrix object and starting from scratch. However, one can modify the matrix values of an already assembled matrix. To do this, first call the `Initialize()` routine to re-initialize the matrix, then set or add-to values as before, and call the `Assemble()` routine to re-assemble before using the matrix. Re-initialization and re-assembly are very cheap, essentially a no-op in the current implementation of the code.

## 5.2 IJ Vector Interface

The following example code illustrates the basic usage of the IJ interface for building vectors:

```
MPI_Comm      comm;
HYPRE_IJVector ij_vector;
HYPRE_ParVector par_vector;
int           jlower, jupper;
int           nvalues;
int           *indices;
double        *values;

HYPRE_IJVectorCreate(comm, jlower, jupper, &ij_vector);
HYPRE_IJVectorSetObjectType(ij_vector, HYPRE_PARCSR);
HYPRE_IJVectorInitialize(ij_vector);

/* set vector values */
HYPRE_IJVectorSetValues(ij_vector, nvalues, indices, values);
...
```

```
HYPRE_IJVectorAssemble(ij_vector);
HYPRE_IJVectorGetObject(ij_vector, (void **) &par_vector);
```

The `Create()` routine creates an empty vector object that lives on the `comm` communicator. This is a collective call, with each process passing its own index extents, `jlower` and `jupper`. The names of these extent parameters begin with a `j` because we typically think of matrix-vector multiplies as the fundamental operation involving both matrices and vectors. For matrix-vector multiplies, the vector partitioning should match the column partitioning of the matrix (which also uses the `j` notation). For linear system solves, these extents will typically match the row partitioning of the matrix as well.

The `SetObjectType()` routine sets the underlying vector storage type to `HYPRE_PARCSR` (this is the only storage type currently supported). The `Initialize()` routine indicates that the vector coefficients (or values) are ready to be set. This routine may or may not involve the allocation of memory for the coefficient data, depending on the implementation.

The `SetValues()` routine sets the vector values for some number (`nvalues`) of indices. The values can be modified with the `AddToValues()` routine. Note that while `AddToValues()` will add to values on other processors, `SetValues()` does not set values on other processors. Instead if a user calls `SetValues()` on processor  $i$  to set a value belonging to processor  $j$ , processor  $i$  will erase all previous occurrences of this matrix coefficient, so they will not contribute to this value on processor  $j$ . The actual value has to be set on processor  $j$ .

The `Assemble()` routine is a trivial collective call, and finalizes the vector assembly, making the vector “ready to use”. The `GetObject()` routine retrieves the built vector object so that it can be passed on to `hypr` solvers that use the `ParVector` internal storage format.

Vector values can be modified in much the same way as with matrices by first re-initializing the vector with the `Initialize()` routine.

### 5.3 A Scalable Interface

As explained in the previous sections, problem data is passed to the `hypr` library in its distributed form. However, as is typically the case for a parallel software library, some information regarding the global distribution of the data will be needed for `hypr` to perform its function. In particular, a solver algorithm requires that a processor obtain “nearby” data from other processors in order to complete the solve. While a processor may easily determine what data it needs from other processors, it may not know which processor owns the data it needs. Therefore, processors must determine their communication partners, or neighbors.

The straightforward approach to determining neighbors involves constructing a global partition of the data. This approach, however, requires  $O(P)$  storage and computations and is not scalable for machines with tens of thousands of processors. The *assumed partition* algorithm was developed to address this problem [4]. It is used by default in `hypr` and is recommended in general. For modest numbers of processors (less than a hundred or so), a global partition may produce slightly faster results and can be turned on by compiling the library as detailed in Section 7.2.1.

## Chapter 6

# Solvers and Preconditioners

There are several solvers available in *hypr* via different conceptual interfaces (see Table 6.1). Note that there are a few additional solvers and preconditioners not mentioned in the table that can be used only through the FEI interface and are described in Paragraph 6.14. The procedure for setup and use of solvers and preconditioners is largely the same. We will refer to them both as solvers in the sequel except when noted. In normal usage, the preconditioner is chosen and constructed before the solver, and then handed to the solver as part of the solver's setup. In the following, we assume the most common usage pattern in which a single linear system is set up and then solved with a single righthand side. We comment later on considerations for other usage patterns.

### Setup:

1. **Pass to the solver the information defining the problem.** In the typical user cycle, the user has passed this information into a matrix through one of the conceptual interfaces prior to setting up the solver. In this situation, the problem definition information is then passed to the solver by passing the constructed matrix into the solver. As described before, the matrix and solver must be compatible, in that the matrix must provide the services needed by the solver. Krylov solvers, for example, need only a matrix-vector multiplication. Most preconditioners, on the other hand, have additional requirements such as access to the matrix coefficients.
2. **Create the solver/preconditioner** via the `Create()` routine.
3. **Choose parameters for the preconditioner and/or solver.** Parameters are chosen through the `Set()` calls provided by the solver. Throughout *hypr*, we have made our best effort to give all parameters reasonable defaults if not chosen. However, for some preconditioners/solvers the best choices for parameters depend on the problem to be solved. We give recommendations in the individual sections on how to choose these parameters. Note that in *hypr*, convergence criteria can be chosen after the preconditioner/solver has been setup. For a complete set of all available parameters see the Reference Manual.

Solvers	System Interfaces			
	Struct	SStruct	FEI	IJ
Jacobi	X	X		
SMG	X	X		
PFMG	X	X		
Split		X		
SysPFMG		X		
FAC		X		
Maxwell		X		
BoomerAMG		X	X	X
AMS		X	X	X
ADS		X	X	X
MLI		X	X	X
ParaSails		X	X	X
Euclid		X	X	X
PILUT		X	X	X
PCG	X	X	X	X
GMRES	X	X	X	X
FlexGMRES	X	X	X	X
LGMRES	X	X		X
BiCGSTAB	X	X	X	X
Hybrid	X	X	X	X
LOBPCG	X	X		X

Table 6.1: Current solver availability via *hypr* conceptual interfaces.

4. **Pass the preconditioner to the solver.** For solvers that are not preconditioned, this step is omitted. The preconditioner is passed through the `SetPrecond()` call.
5. **Set up the solver.** This is just the `Setup()` routine. At this point the matrix and right hand side is passed into the solver or preconditioner. Note that the actual right hand side is not used until the actual solve is performed.

At this point, the solver/preconditioner is fully constructed and ready for use.

## Use:

1. **Set convergence criteria.** Convergence can be controlled by the number of iterations, as well as various tolerances such as relative residual, preconditioned residual, etc. Like all parameters, reasonable defaults are used. Users are free to change these, though care must be taken. For example, if an iterative method is used as a preconditioner for a Krylov method, a constant number of iterations is usually required.

2. **Solve the system.** This is just the `Solve()` routine.

## Finalize:

1. **Free the solver or preconditioner.** This is done using the `Destroy()` routine.

## Synopsis

In general, a solver (let's call it `SOLVER`) is set up and run using the following routines, where `A` is the matrix, `b` the right hand side and `x` the solution vector of the linear system to be solved:

```

/* Create Solver */
int HYPRE_SOLVERCreate(MPI_COMM_WORLD, &solver);

/* set certain parameters if desired */
HYPRE_SOLVERSetTol(solver, 1.e-8);
.
.
/* Set up Solver */
HYPRE_SOLVERSetup(solver, A, b, x);
/* Solve the system */
HYPRE_SOLVERsolve(solver, A, b, x);
/* Destroy the solver */
HYPRE_SOLVERDestroy(solver);

```

In the following sections, we will give brief descriptions of the available *hypre* solvers with some suggestions on how to choose the parameters as well as references for users who are interested in a more detailed description and analysis of the solvers. A complete list of all routines that are available can be found in the reference manual.

## 6.1 SMG

SMG is a parallel semicoarsening multigrid solver for the linear systems arising from finite difference, finite volume, or finite element discretizations of the diffusion equation,

$$\nabla \cdot (D\nabla u) + \sigma u = f \quad (6.1)$$

on logically rectangular grids. The code solves both 2D and 3D problems with discretization stencils of up to 9-point in 2D and up to 27-point in 3D. See [31, 6, 12] for details on the algorithm and its parallel implementation/performance.

SMG is a particularly robust method. The algorithm semicoarsens in the z-direction and uses plane smoothing. The xy plane-solves are effected by one V-cycle of the 2D SMG algorithm, which semicoarsens in the y-direction and uses line smoothing.

## 6.2 PFMG

PFMG is a parallel semicoarsening multigrid solver similar to SMG. See [1, 12] for details on the algorithm and its parallel implementation/performance.

The main difference between the two methods is in the smoother: PFMG uses simple pointwise smoothing. As a result, PFMG is not as robust as SMG, but is much more efficient per V-cycle.

## 6.3 SysPFMG

SysPFMG is a parallel semicoarsening multigrid solver for systems of elliptic PDEs. It is a generalization of PFMG, with the interpolation defined only within the same variable. The relaxation is of nodal type- all variables at a given point location are simultaneously solved for in the relaxation.

Although SysPFMG is implemented through the SStruct interface, it can be used only for problems with one grid part. Ideally, the solver should handle any of the seven variable types (cell-, node-, xface-, yface-, zface-, xedge-, yedge-, and zedge-based). However, it has been completed only for cell-based variables.

## 6.4 SplitSolve

SplitSolve is a parallel block Gauss-Seidel solver for semi-structured problems with multiple parts. For problems with only one variable, it can be viewed as a domain-decomposition solver with no grid overlapping.

Consider a multiple part problem given by the linear system  $Ax = b$ . Matrix  $A$  can be decomposed into a structured intra-variable block diagonal component  $M$  and a component  $N$  consisting of the inter-variable blocks and any unstructured connections between the parts. SplitSolve performs the iteration

$$x_{k+1} = \tilde{M}^{-1}(b + Nx_k),$$

where  $\tilde{M}^{-1}$  is a decoupled block-diagonal V(1,1) cycle, a separate cycle for each part and variable type. There are two V-cycle options, SMG and PFMG.

## 6.5 FAC

FAC is a parallel fast adaptive composite grid solver for finite volume, cell-centred discretizations of smooth diffusion coefficient problems. To be precise, it is a FACx algorithm since the patch solves consist of only relaxation sweeps. For details of the basic overall algorithms, see [28]. Algorithmic particularities include formation of non-Galerkin coarse-grid operators (i.e., coarse-grid operators underlying refinement patches are automatically generated) and non-stored linear/constant interpolation/restriction operators. Implementation particularities include a processor redistribution of the generated coarse-grid operators so that intra-level communication between adaptive mesh refinement (AMR) levels during the solve phase is kept to a minimum. This redistribution is hidden from the user.

The user input is essentially a linear system describing the *composite* operator, and the refinement factors between the AMR levels. To form this composite linear system, the AMR grid is described using semi-structured grid parts. Each AMR level grid corresponds to a separate part so that this level grid is simply a collection of boxes, all with the same refinement factor, i.e., it is a struct grid. However, several restrictions are imposed on the patch (box) refinements. First, a refinement box must cover all underlying coarse cells- i.e., refinement of a partial coarse cell is not permitted. Also, the refined/coarse indices must follow a mapping: with  $[r_1, r_2, r_3]$  denoting the refinement factor and  $[a_1, a_2, a_3] \times [b_1, b_2, b_3]$  denoting the coarse subbox to be refined, the mapping to the refined patch is

$$[r_1 * a_1, r_2 * a_2, r_3 * a_3] \times [r_1 * b_1 + r_1 - 1, r_2 * b_2 + r_2 - 1, r_3 * b_3 + r_3 - 1].$$

With the AMR grid constructed under these restrictions, the composite matrix can be formed. Since the AMR levels correspond to semi-structured grid parts, the composite matrix is a semi-structured matrix consisting of structured components within each part, and unstructured components describing the coarse-to-fine/fine-to-coarse connections. The structured and unstructured components can be set using stencils and the HYPRE\_SStructGraphAddEntries routine, respectively. The matrix coefficients can be filled after setting these non-zero patterns. Between each pair of successive AMR levels, the coarse matrix underlying the refinement patch must be the identity and the corresponding rows of the rhs must be zero. These can be performed using routines HYPRE\_SStructFACZeroCFSten (to zero off the stencil values reaching from coarse boxes into refinement boxes), HYPRE\_SStructFACZeroFCSten (to zero off the stencil values reaching from refinement boxes into coarse boxes), HYPRE\_SStructFACZeroAMRMatrixData (to set the identity at coarse grid points underlying a refinement patch), and HYPRE\_SStructFACZeroAMRVectorData (to zero off a vector at coarse grid points underlying a refinement patch). These routines can simplify the user's matrix setup. For example, consider two successive AMR levels with the coarser level consisting of one box and the finer level consisting of a collection of boxes. Rather than distinguishably setting the stencil values and the identity in the appropriate locations, the user can set the stencil values on the whole coarse grid using the HYPRE\_SStructMatrixSetBoxValues routine and then zero off the appropriate values using the above zeroing routines.

The coarse matrix underlying these patches are algebraically generated by operator-collapsing the refinement patch operator and the fine-to-coarse coefficients (this is why stencil values reaching out of a part must be zeroed). This matrix is re-distributed so that each processor has all of its coarse-grid operator.

To solve the coarsest AMR level, a PFMG V cycle is used. Note that a minimum of two AMR levels are needed for this solver.

## 6.6 Maxwell

Maxwell is a parallel solver for edge finite element discretization of the curl-curl formulation of the Maxwell equation

$$\nabla \times \alpha \nabla \times E + \beta E = f, \beta > 0$$

on semi-structured grids. Details of the algorithm can be found in [23]. The solver can be viewed as an operator-dependent multiple-coarsening algorithm for the Helmholtz decomposition of the error correction. Input to this solver consist of only the linear system and a gradient operator. In fact, if the orientation of the edge elements conforms to a lexicographical ordering of the nodes of the grid, then the gradient operator can be generated with the routine `HYPRE_MaxwellGrad`: at grid points  $(i, j, k)$  and  $(i - 1, j, k)$ , the produced gradient operator takes values 1 and  $-1$  respectively, which is the correct gradient operator for the appropriate edge orientation. Since the gradient operator is normalized (i.e.,  $h$  independent) the edge finite element must also be normalized in the discretization.

This solver is currently developed for perfectly conducting boundary condition (Dirichlet). Hence, the rows and columns of the matrix that corresponding to the grid boundary must be set to the identity or zeroed off. This can be achieved with the routines `HYPRE_SStructMaxwellPhysBdy` and `HYPRE_SStructMaxwellEliminateRowsCols`. The former identifies the ranks of the rows that are located on the grid boundary, and the latter adjusts the boundary rows and cols. As usual, the rhs of the linear system must also be zeroed off at the boundary rows. This can be done using `HYPRE_SStructMaxwellZeroVector`.

With the adjusted linear system and a gradient operator, the user can form the Maxwell multigrid solver using several different edge interpolation schemes. For problems with smooth coefficients, the natural Nedelec interpolation operator can be used. This is formed by calling `HYPRE_SStructMaxwellSetConstantCoef` with the flag  $> 0$  before setting up the solver, otherwise the default edge interpolation is an operator-collapsing/element-agglomeration scheme. This is suitable for variable coefficients. Also, before setting up the solver, the user must pass the gradient operator, whether user or `HYPRE_MaxwellGrad` generated, with `HYPRE_SStructMaxwellSetGrad`. After these preliminary calls, the Maxwell solver can be setup by calling `HYPRE_SStructMaxwellSetup`.

There are two solver cycling schemes that can be used to solve the linear system. To describe these, one needs to consider the augmented system operator

$$\mathbf{A} = \begin{bmatrix} A_{ee} & A_{en} \\ A_{ne} & A_{nn} \end{bmatrix}, \quad (6.2)$$

where  $A_{ee}$  is the stiffness matrix corresponding to the above curl-curl formulation,  $A_{nn}$  is the nodal Poisson operator created by taking the Galerkin product of  $A_{ee}$  and the gradient operator, and  $A_{ne}$  and  $A_{en}$  are the nodal-edge coupling operators (see [23]). The algorithm for this Maxwell solver is based on forming a multigrid hierarchy to this augmented system using the block-diagonal interpolation operator

$$\mathbf{P} = \begin{bmatrix} P_e & 0 \\ 0 & P_n \end{bmatrix},$$

where  $P_e$  and  $P_n$  are respectively the edge and nodal interpolation operators determined individually from  $A_{ee}$  and  $A_{nn}$ . Taking a Galerkin product between  $\mathbf{A}$  and  $\mathbf{P}$  produces the next coarse augmented operator, which also has the nodal-edge coupling operators. Applying this procedure recursively produces nodal-edge coupling operators at all levels. Now, the first solver cycling scheme,



HYPRE\_SStructMaxwellSolve, keeps these coupling operators on all levels of the V-cycle. The second, cheaper scheme, HYPRE\_SStructMaxwellSolve2, keeps the coupling operators only on the finest level, i.e., separate edge and nodal V-cycles that couple only on the finest level.

## 6.7 Hybrid

The hybrid solver is designed to detect whether a multigrid preconditioner is needed when solving a linear system and possibly avoid the expensive setup of a preconditioner if a system can be solved efficiently with a diagonally scaled Krylov solver, e.g. a strongly diagonally dominant system. It first uses a diagonally scaled Krylov solver, which can be chosen by the user (the default is conjugate gradient, but one should use GMRES if the matrix of the linear system to be solved is nonsymmetric). It monitors how fast the Krylov solver converges. If there is not sufficient progress, the algorithm switches to a preconditioned Krylov solver.

If used through the `Struct` interface, the solver is called `StructHybrid` and can be used with the preconditioners `SMG` and `PFMG` (default). It is called `ParCSRHybrid`, if used through the `IJ` interface and is used here with `BoomerAMG`. The user can determine the average convergence speed by setting a convergence tolerance  $0 \leq \theta < 1$  via the routine `HYPRE_StructHybridSetConvergenceTol` or `HYPRE_StructParCSRHybridSetConvergenceTol`. The default setting is 0.9.

The average convergence factor  $\rho_i = \left(\frac{\|r_i\|}{\|r_0\|}\right)^{1/i}$  is monitored within the chosen Krylov solver, where  $r_i = b - Ax_i$  is the  $i$ -th residual. Convergence is considered too slow when

$$\left(1 - \frac{|\rho_i - \rho_{i-1}|}{\max(\rho_i, \rho_{i-1})}\right) \rho_i > \theta. \quad (6.3)$$

When this condition is fulfilled the hybrid solver switches from a diagonally scaled Krylov solver to a preconditioned solver.

## 6.8 BoomerAMG

BoomerAMG is a parallel implementation of the algebraic multigrid method [30]. It can be used both as a solver or as a preconditioner. The user can choose between various different parallel coarsening techniques, interpolation and relaxation schemes. While the default settings work fairly well for two-dimensional diffusion problems, for three-dimensional diffusion problems, it is recommended to choose a lower complexity coarsening like `HMIS` or `PMIS` (coarsening 10 or 8) and combine it with a distance-two interpolation (interpolation 6 or 7), that is also truncated to 4 or 5 elements per row. Additional reduction in complexity and increased scalability can often be achieved using one or two levels of aggressive coarsening.

### 6.8.1 Parameter Options

Various BoomerAMG functions and options are mentioned below. However, for a complete listing and description of all available functions, see the reference manual.

BoomerAMG's Create function differs from the synopsis in that it has only one parameter `HYPRE_BoomerAMGCreate(HYPRE_Solver *solver)`. It uses the communicator of the matrix A.

### 6.8.2 Coarsening Options

Coarsening can be set by the user using the function `HYPRE_BoomerAMGSetCoarsenType`. A detailed description of various coarsening techniques can be found in [19, 37].

Various coarsening techniques are available:

- the Cleary-Luby-Jones-Plassman (CLJP) coarsening,
- the Falgout coarsening which is a combination of CLJP and the classical RS coarsening algorithm,
- CGC and CGC-E coarsenings [18, 17],
- PMIS and HMIS coarsening algorithms which lead to coarsenings with lower complexities [10] as well as
- aggressive coarsening, which can be applied to any of the coarsening techniques mentioned above and thus achieving much lower complexities and lower memory use [32].

To use aggressive coarsening the user has to set the number of levels to which he wants to apply aggressive coarsening (starting with the finest level) via `HYPRE_BoomerAMGSetAggNumLevels`. Since aggressive coarsening requires long range interpolation, multipass interpolation is always used on levels with aggressive coarsening, unless the user specifies another long-range interpolation suitable for aggressive coarsening.

Note that the default coarsening is HMIS [10].

### 6.8.3 Interpolation Options

Various interpolation techniques can be set using `HYPRE_BoomerAMGSetInterpType`:

- the “classical” interpolation as defined in [30],
- direct interpolation [32],
- standard interpolation [32],
- an extended “classical” interpolation, which is a long range interpolation and is recommended to be used with PMIS and HMIS coarsening for harder problems [9],
- multipass interpolation [32],
- two-stage interpolation [38],
- Jacobi interpolation [32],

- the “classical” interpolation modified for hyperbolic PDEs.

Jacobi interpolation is only use to improve certain interpolation operators and can be used with `HYPRE_BoomerAMGSetPostInterpType`. Since some of the interpolation operators might generate large stencils, it is often possible and recommended to control complexity and truncate the interpolation operators using `HYPRE_BoomerAMGSetTruncFactor` and/or `HYPRE_BoomerAMGSetPMaxElmts`, or `HYPRE_BoomerAMGSetJacobiTruncTheshold` (for Jacobi interpolation only).

Note that the default interpolation is extended+i interpolation [9] truncated to 4 elements per row.

#### 6.8.4 Non-Galerkin Options

In order to reduce communication, there is a non-Galerkin coarse grid sparsification option available [15]. This option can be used by itself or with existing strategies to reduce communication such as aggressive coarsening and HMIS coarsening. To use, call `HYPRE_BoomerAMGSetNonGalerkTol`, which gives BoomerAMG a list of level specific non-Galerkin drop tolerances. It is common to drop more aggressively on coarser levels. A common choice of drop-tolerances is `[0.0, 0.01, 0.05]` where the value of 0.0 will skip the non-Galerkin process on the first coarse level (level 1), use a drop-tolerance of 0.01 on the second coarse level (level 2) and then use 0.05 on all subsequent coarse levels. While still experimental, this capability has significantly improved performance on a variety of problems. See the `ij` driver for an example usage and the reference manual for more details.

#### 6.8.5 Smoother Options

A good overview of parallel smoothers and their properties can be found in [2]. Various of the described relaxation techniques are available:

- weighted Jacobi relaxation,
- a hybrid Gauss-Seidel / Jacobi relaxation scheme,
- a symmetric hybrid Gauss-Seidel / Jacobi relaxation scheme,
- 11-Gauss-Seidel or Jacobi,
- Chebyshev smoothers,
- hybrid block and Schwarz smoothers [36],
- ILU and approximate inverse smoothers.

Point relaxation schemes can be set using `HYPRE_BoomerAMGSetRelaxType` or, if one wants to specifically set the up cycle, down cycle or the coarsest grid, with `HYPRE_BoomerAMGSetCycleRelaxType`. To use the more complicated smoothers, e.g. block, Schwarz, ILU smoothers, it is necessary to use `HYPRE_BoomerAMGSetSmoothType` and `HYPRE_BoomerAMGSetSmoothNumLevels`. There are further parameter choices for the individual smoothers, which are described in the reference manual. The

default relaxation type is hybrid Gauss-Seidel with CF-relaxation (relax first the C-, then the F-points) on the down cycle and FC-relaxation on the up-cycle. Note that if BoomerAMG is used as a preconditioner for conjugate gradient, it is necessary to use a symmetric smoother such as weighted Jacobi or hybrid symmetric Gauss-Seidel.

### 6.8.6 AMG for systems of PDEs

If the users wants to solve systems of PDEs and can provide information on which variables belong to which function, BoomerAMG's systems AMG version can also be used. Functions that enable the user to access the systems AMG version are `HYPRE_BoomerAMGSetNumFunctions`, `HYPRE_BoomerAMGSetDofFunc` and `HYPRE_BoomerAMGSetNodal`.

If the user can provide the near null-space vectors, such as the rigid body modes for linear elasticity problems, an interpolation is available that will incorporate these vectors with `HYPRE_BoomerAMGSetInterpVect` and `HYPRE_BoomerAMGSetInterpVecVariant`. This can lead to improved convergence and scalability [3].

### 6.8.7 Special AMG Cycles

The default cycle is a V(1,1)-cycle, however it is possible to change the number of sweeps of the up- and down-cycle as well as the coare grid. One can also choose a W-cycle, however for parallel processing this is not recommended, since it is not scalable.

BoomerAMG also provides an additive V(1,1)-cycle as well as a mult-additive V(1,1)-cycle and a simplified versioni [35]. The additive variants can only be used with weighted Jacobi or l1-Jacobi smoothing.

### 6.8.8 Miscellaneous

For best performance, it might be necessary to set certain parameters, which will affect both coarsening and interpolation. One important parameter is the strong threshold, which can be set using the function `HYPRE_BoomerAMGSetStrongThreshold`. The default value is 0.25, which appears to be a good choice for 2-dimensional problems and the low complexity coarsening algorithms. For 3-dimensional problems a better choice appears to be 0.5, when using the default coarsening algorithm. However, the choice of the strength threshold is problem dependent and therefore there could be better choices than the two suggested ones.

## 6.9 AMS

AMS (the Auxiliary-space Maxwell Solver) is a parallel unstructured Maxwell solver for edge finite element discretizations of the variational problem

$$\text{Find } \mathbf{u} \in \mathbf{V}_h : \quad (\alpha \nabla \times \mathbf{u}, \nabla \times \mathbf{v}) + (\beta \mathbf{u}, \mathbf{v}) = (\mathbf{f}, \mathbf{v}), \quad \text{for all } \mathbf{v} \in \mathbf{V}_h. \quad (6.4)$$

Here  $\mathbf{V}_h$  is the lowest order Nedelec (edge) finite element space, and  $\alpha > 0$  and  $\beta \geq 0$  are scalar, or SPD matrix coefficients. AMS was designed to be scalable on problems with variable coefficients,

and allows for  $\beta$  to be zero in part or the whole domain. In either case the resulting problem is only semidefinite, and for solvability the right-hand side should be chosen to satisfy compatibility conditions.

AMS is based on the auxiliary space methods for definite Maxwell problems proposed in [20]. For more details, see [27].

### 6.9.1 Overview

Let  $\mathbf{A}$  and  $\mathbf{b}$  be the stiffness matrix and the load vector corresponding to (6.4). Then the resulting linear system of interest reads,

$$\mathbf{A} \mathbf{x} = \mathbf{b}. \quad (6.5)$$

The coefficients  $\alpha$  and  $\beta$  are naturally associated with the “stiffness” and “mass” terms of  $\mathbf{A}$ . Besides  $\mathbf{A}$  and  $\mathbf{b}$ , AMS requires the following additional user input:

1. The discrete gradient matrix  $G$  representing the edges of the mesh in terms of its vertices.  $G$  has as many rows as the number of edges in the mesh, with each row having two nonzero entries:  $+1$  and  $-1$  in the columns corresponding to the vertices composing the edge. The sign is determined based on the orientation of the edge. We require that  $G$  includes all (interior and boundary) edges and vertices.
2. The representations of the constant vector fields  $(1, 0, 0)$ ,  $(0, 1, 0)$  and  $(0, 0, 1)$  in the  $\mathbf{V}_h$  basis, given as three vectors:  $G_x$ ,  $G_y$ , and  $G_z$ . Note that since no boundary conditions are imposed on  $G$ , the above vectors can be computed as  $G_x = Gx$ ,  $G_y = Gy$  and  $G_z = Gz$ , where  $x$ ,  $y$ , and  $z$  are vectors representing the coordinates of the vertices of the mesh.

In addition to the above quantities, AMS can utilize the following (optional) information:

- (3.) The Poisson matrices  $A_\alpha$  and  $A_\beta$ , corresponding to assembling of the forms  $(\alpha \nabla u, \nabla v) + (\beta \nabla u, \nabla v)$  and  $(\beta \nabla u, \nabla v)$  using standard linear finite elements on the same mesh.

Internally, AMS proceeds with the construction of the following additional objects:

- $A_G$  – a matrix associated with the mass term which is either  $G^T \mathbf{A} G$ , or the Poisson matrix  $A_\beta$  (if given).
- $\mathbf{\Pi}$  – the matrix representation of the interpolation operator from vector linear to edge finite elements.
- $\mathbf{A}_\mathbf{\Pi}$  – a matrix associated with the stiffness term which is either  $\mathbf{\Pi}^T \mathbf{A} \mathbf{\Pi}$  or a block-diagonal matrix with diagonal blocks  $A_\alpha$  (if given).
- $B_G$  and  $\mathbf{B}_\mathbf{\Pi}$  – efficient (AMG) solvers for  $A_G$  and  $\mathbf{A}_\mathbf{\Pi}$ .

The solution procedure then is a three-level method using smoothing in the original edge space and subspace corrections based on  $B_G$  and  $\mathbf{B}_\mathbf{\Pi}$ . We can employ a number of options here utilizing various combinations of the smoother and solvers in additive or multiplicative fashion. If  $\beta$  is identically zero one can skip the subspace correction associated with  $G$ , in which case the solver is a two-level method.

### 6.9.2 Sample Usage

AMS can be used either as a solver or as a preconditioner. Below we list the sequence of *hypr*e calls needed to create and use it as a solver. See example code `ex15.c` for a complete implementation. We start with the allocation of the `HYPRE_Solver` object:

```
HYPRE_Solver solver;
HYPRE_AMSCreate(&solver);
```

Next, we set a number of solver parameters. Some of them are optional, while others are necessary in order to perform the solver setup.

AMS offers the option to set the space dimension. By default we consider the dimension to be 3. The only other option is 2, and it can be set with the function given below. We note that a 3D solver will still work for a 2D problem, but it will be slower and will require more memory than necessary.

```
HYPRE_AMSSetDimension(solver, dim);
```

The user is required to provide the discrete gradient matrix  $G$ . AMS expects a matrix defined on the whole mesh with no boundary edges/nodes excluded. It is essential to **not** impose any boundary conditions on  $G$ . Regardless of which *hypr*e conceptual interface was used to construct  $G$ , one can obtain a ParCSR version of it. This is the expected format in the following function.

```
HYPRE_AMSSetDiscreteGradient(solver, G);
```

In addition to  $G$ , we need one additional piece of information in order to construct the solver. The user has the option to choose either the coordinates of the vertices in the mesh or the representations of the constant vector fields in the edge element basis. In both cases three *hypr*e parallel vectors should be provided. For 2D problems, the user can set the third vector to `NULL`. The corresponding function calls read:

```
HYPRE_AMSSetCoordinateVectors(solver,x,y,z);
```

or

```
HYPRE_AMSSetEdgeConstantVectors(solver,
                                one_zero_zero,
                                zero_one_zero,
                                zero_zero_one);
```

The vectors `one_zero_zero`, `zero_one_zero` and `zero_zero_one` above correspond to the constant vector fields  $(1, 0, 0)$ ,  $(0, 1, 0)$  and  $(0, 0, 1)$ .

The remaining solver parameters are optional. For example, the user can choose a different cycle type by calling

```
HYPRE_AMSSetCycleType(solver, cycle_type); /* default value: 1 */
```

The available cycle types in AMS are:

- `cycle_type=1`: multiplicative solver (01210)
- `cycle_type=2`: additive solver (0 + 1 + 2)
- `cycle_type=3`: multiplicative solver (02120)
- `cycle_type=4`: additive solver (010 + 2)
- `cycle_type=5`: multiplicative solver (0102010)
- `cycle_type=6`: additive solver (1 + 020)
- `cycle_type=7`: multiplicative solver (0201020)
- `cycle_type=8`: additive solver (0(1 + 2)0)
- `cycle_type=11`: multiplicative solver (013454310)
- `cycle_type=12`: additive solver (0 + 1 + 3 + 4 + 5)
- `cycle_type=13`: multiplicative solver (034515430)
- `cycle_type=14`: additive solver (01(3 + 4 + 5)10)

Here we use the following convention for the three subspace correction methods: 0 refers to smoothing, 1 stands for BoomerAMG based on  $B_G$ , and 2 refers to a call to BoomerAMG for  $\mathbf{B}_{\Pi}$ . The values 3, 4 and 5 refer to the scalar subspaces corresponding to the  $x$ ,  $y$  and  $z$  components of  $\Pi$ .

The abbreviation  $xyz$  for  $x, y, z \in \{0, 1, 2, 3, 4, 5\}$  refers to a multiplicative subspace correction based on solvers  $x, y, y$ , and  $z$  (in that order). The abbreviation  $x+y+z$  stands for an additive subspace correction method based on  $x, y$  and  $z$  solvers. The additive cycles are meant to be used only when AMS is called as a preconditioner. In our experience the choices `cycle_type=1,5,8,11,13` often produced fastest solution times, while `cycle_type=7` resulted in smallest number of iterations.

Additional solver parameters, such as the maximum number of iterations, the convergence tolerance and the output level, can be set with

```
HYPRE_AMSSetMaxIter(solver, maxit);      /* default value: 20 */
HYPRE_AMSSetTol(solver, tol);           /* default value: 1e-6 */
HYPRE_AMSSetPrintLevel(solver, print);  /* default value: 1 */
```

More advanced parameters, affecting the smoothing and the internal AMG solvers, can be set with the following three functions:

```
HYPRE_AMSSetSmoothingOptions(solver, 2, 1, 1.0, 1.0);
HYPRE_AMSSetAlphaAMGOptions(solver, 10, 1, 3, 0.25, 0, 0);
HYPRE_AMSSetBetaAMGOptions(solver, 10, 1, 3, 0.25, 0, 0);
```

For (singular) problems where  $\beta = 0$  in the whole domain, different (in fact simpler) version of the AMS solver is offered. To allow for this simplification, use the following `hypr` call

```
HYPRE_AMSSetBetaPoissonMatrix(solver, NULL);
```

If  $\beta$  is zero only in parts of the domain, the problem is still singular, but the AMS solver will try to detect this and construct a non-singular preconditioner. Though this often works well in practice, AMS also provides a more robust version for solving such singular problems to very low convergence tolerances. This version takes advantage of additional information: the list of nodes which are interior to a zero-conductivity region provided by the function

```
HYPRE_AMSSetInteriorNodes(solver, HYPRE_ParVector interior_nodes);
```

A node is interior, if its entry in the `interior_nodes` array is 1.0. Based on this array, a restricted discrete gradient operator  $G_0$  is constructed, and AMS is then defined based on the matrix  $\mathbf{A} + \delta G_0^T G_0$  which is non-singular, and a small  $\delta > 0$  perturbation of  $\mathbf{A}$ . When iterating with this preconditioner, it is advantageous to project on the compatible subspace  $Ker(G_0^T)$ . This can be done periodically, or manually through the functions

```
HYPRE_AMSSetProjectionFrequency(solver, int projection_frequency);
HYPRE_AMSProjectOutGradients(solver, HYPRE_ParVector x);
```

Two additional matrices are constructed in the setup of the AMS method—one corresponding to the coefficient  $\alpha$  and another corresponding to  $\beta$ . This may lead to prohibitively high memory requirements, and the next two function calls may help to save some memory. For example, if the Poisson matrix with coefficient  $\beta$  (denoted by `Abeta`) is available then one can avoid one matrix construction by calling

```
HYPRE_AMSSetBetaPoissonMatrix(solver, Abeta);
```

Similarly, if the Poisson matrix with coefficient  $\alpha$  is available (denoted by `Aalpha`) the second matrix construction can also be avoided by calling

```
HYPRE_AMSSetAlphaPoissonMatrix(solver, Aalpha);
```

Note the following regarding these functions:

- Both of them change their input. More specifically, the diagonal entries of the input matrix corresponding to eliminated degrees of freedom (due to essential boundary conditions) are penalized.
- It is assumed that their essential boundary conditions of `A`, `Abeta` and `Aalpha` are on the same part of the boundary.
- `HYPRE_AMSSetAlphaPoissonMatrix` forces the AMS method to use a simpler, but weaker (in terms of convergence) method. With this option, the multiplicative AMS cycle is not guaranteed to converge with the default parameters. The reason for this is the fact the solver is not variationally obtained from the original matrix (it utilizes the auxiliary Poisson-like matrices `Abeta` and `Aalpha`). Therefore, it is recommended in this case to use AMS as preconditioner only.



After the above calls, the solver is ready to be constructed. The user has to provide the stiffness matrix  $\mathbf{A}$  (in ParCSR format) and the *hypr* parallel vectors  $\mathbf{b}$  and  $\mathbf{x}$ . (The vectors are actually not used in the current AMS setup.) The setup call reads,

```
HYPRE_AMSSetup(solver, A, b, x);
```

It is important to note the order of the calling sequence. For example, do **not** call `HYPRE_AMSSetup` before calling `HYPRE_AMSSetDiscreteGradient` and one of the functions `HYPRE_AMSSetCoordinateVectors` or `HYPRE_AMSSetEdgeConstantVectors`.

Once the setup has completed, we can solve the linear system by calling

```
HYPRE_AMSSolve(solver, A, b, x);
```

Finally, the solver can be destroyed with

```
HYPRE_AMSDestroy(&solver);
```

More details can be found in the files `ams.h` and `ams.c` located in the `parcsr_ls` directory.

### 6.9.3 High-order Discretizations

In addition to the interface for the lowest-order Nedelec elements described in the previous subsections, AMS also provides support for (arbitrary) high-order Nedelec element discretizations. Since the robustness of AMS depends on the performance of BoomerAMG on the associated (high-order) auxiliary subspace problems, we note that the convergence may not be optimal for large polynomial degrees  $k \geq 1$ .

In the high-order AMS interface, the user does not need to provide the coordinates of the vertices (or the representations of the constant vector fields in the edge basis), but instead should construct and pass the Nedelec interpolation matrix  $\mathbf{\Pi}$  which maps (high-order) vector nodal finite elements into the (high-order) Nedelec space. In other words,  $\mathbf{\Pi}$  is the (parallel) matrix representation of the interpolation mapping from  $P_k^3/Q_k^3$  into  $ND_k$ , see [20, 27]. We require this matrix as an input, since in the high-order case its entries very much depend on the particular choice of the basis functions in the edge and nodal spaces, as well as on the geometry of the mesh elements. The columns of  $\mathbf{\Pi}$  should use a node-based numbering, where the  $x/y/z$  components of the first node (vertex or high-order degree of freedom) should be listed first, followed by the  $x/y/z$  components of the second node and so on (see the documentation of `HYPRE_BoomerAMGSetDofFunc`).

Similarly to the Nedelec interpolation, the discrete gradient matrix  $G$  should correspond to the mapping  $\varphi \in P_k^3/Q_k^3 \mapsto \nabla\varphi \in ND_k$ , so even though its values are still independent of the mesh coordinates, they will not be  $\pm 1$ , but will be determined by the particular form of the high-order basis functions and degrees of freedom.

With these matrices, the high-order setup procedure is simply

```
HYPRE_AMSSetDimension(solver, dim);
HYPRE_AMSSetDiscreteGradient(solver, G);
HYPRE_AMSSetInterpolations(solver, Pi, NULL, NULL, NULL);
```

We remark that the above interface calls can also be used in the lowest-order case (or even other types of discretizations such as those based on the second family of Nedelec elements), but we recommend calling the previously described `HYPRE_AMSSetCoordinateVectors` instead, since this allows AMS to handle the construction and use of  $\mathbf{\Pi}$  internally.

Specifying the monolithic  $\mathbf{\Pi}$  limits the AMS cycle type options to those less than 10. Alternatively one can separately specify the  $x$ ,  $y$  and  $z$  components of  $\mathbf{\Pi}$ :

```
HYPRE_AMSSetInterpolations(solver, NULL, Pix, Piy, Piz);
```

which enables the use of AMS cycle types with index greater than 10. By definition,  $\mathbf{\Pi}^x \varphi = \mathbf{\Pi}(\varphi, 0, 0)$ , and similarly for  $\mathbf{\Pi}^y$  and  $\mathbf{\Pi}^z$ . Each of these matrices has the same sparsity pattern as  $G$ , but their entries depend on the coordinates of the mesh vertices.

Finally, both  $\mathbf{\Pi}$  and its components can be passed to the solver:

```
HYPRE_AMSSetInterpolations(solver, Pi, Pix, Piy, Piz);
```

which will duplicate some memory, but allows for experimentation with all available AMS cycle types.

#### 6.9.4 Non-conforming AMR Grids

AMS could also be applied to problems with adaptive mesh refinement (AMR) posed on non-conforming quadrilateral/hexahedral meshes, see [16] for more details.

On non-conforming grids (assuming also arbitrarily high-order elements), each finite element space has two versions: a conforming one, e.g.  $Q_k^c/ND_k^c$ , where the *hanging* degrees of freedom are constrained by the conforming (*real*) degrees of freedom, and a non-conforming one, e.g.  $Q_k^{nc}/ND_k^{nc}$  where the non-conforming degrees of freedom (hanging and real) are unconstrained. These spaces are related with the conforming prolongation and the pure restriction operators  $P$  and  $R$ , as well as the conforming and non-conforming version of the discrete gradient operator as follows:

$$\begin{array}{ccc} Q_k^c & \xrightarrow{G_c} & ND_k^c \\ P_Q \uparrow \downarrow R_Q & & P_{ND} \uparrow \downarrow R_{ND} \\ Q_k^{nc} & \xrightarrow{G_{nc}} & ND_k^{nc} \end{array}$$

Since the linear system is posed on  $ND_k^c$ , the user needs to provide the conforming discrete gradient matrix  $G_c$  to AMS, using `HYPRE_AMSSetDiscreteGradient`. This matrix is defined by the requirement that the above diagram commutes from  $Q_k^c$  to  $ND_k^{nc}$ , corresponding to the definition

$$G_c = R_{ND} G_{nc} P_Q,$$

i.e. the conforming gradient is computed by starting with a conforming nodal  $Q_k$  function, interpolating it in the hanging nodes, computing the gradient locally and representing it in the Nedelec space on each element (the non-conforming discrete gradient  $G_{nc}$  in the above formula), and disregarding the values in the hanging  $ND_k$  degrees of freedom.

Similar considerations imply that the conforming Nedelec interpolation matrix  $\mathbf{\Pi}_c$  should be defined as

$$\mathbf{\Pi}_c = R_{\text{ND}} \mathbf{\Pi}_{nc} P_{Q^3},$$

with  $\mathbf{\Pi}_{nc}$  computed element-wise as in the previous subsection. Note that in the low-order case,  $\mathbf{\Pi}_c$  can be computed internally in AMS based only  $G_c$  and the conforming coordinates of the vertices  $x_c/y_c/z_c$ , see [16].

## 6.10 ADS

The Auxiliary-space Divergence Solver (ADS) is a parallel unstructured solver similar to AMS, but targeting  $H(\text{div})$  instead of  $H(\text{curl})$  problems. Its usage and options are very similar to those of AMS, and in general the relationship between ADS and AMS is analogous to that between AMS and AMG.

Specifically ADS was designed for the scalable solution of linear systems arising in the finite element discretization of the variational problem

$$\text{Find } \mathbf{u} \in \mathbf{W}_h : \quad (\alpha \nabla \cdot \mathbf{u}, \nabla \cdot \mathbf{v}) + (\beta \mathbf{u}, \mathbf{v}) = (\mathbf{f}, \mathbf{v}), \quad \text{for all } \mathbf{v} \in \mathbf{W}_h, \quad (6.6)$$

where  $\mathbf{W}_h$  is the lowest order Raviart-Thomas (face) finite element space, and  $\alpha > 0$  and  $\beta > 0$  are scalar, or SPD matrix variable coefficients. It is based on the auxiliary space methods for  $H(\text{div})$  problems proposed in [20].

### 6.10.1 Overview

Let  $\mathbf{A}$  and  $\mathbf{b}$  be the stiffness matrix and the load vector corresponding to (6.6). Then the resulting linear system of interest reads,

$$\mathbf{A} \mathbf{x} = \mathbf{b}. \quad (6.7)$$

The coefficients  $\alpha$  and  $\beta$  are naturally associated with the ‘‘stiffness’’ and ‘‘mass’’ terms of  $\mathbf{A}$ . Besides  $\mathbf{A}$  and  $\mathbf{b}$ , ADS requires the following additional user input:

1. The discrete curl matrix  $C$  representing the faces of the mesh in terms of its edges.  $C$  has as many rows as the number of faces in the mesh, with each row having nonzero entries  $+1$  and  $-1$  in the columns corresponding to the edges composing the face. The sign is determined based on the orientation of the edges relative to the face. We require that  $C$  includes all (interior and boundary) faces and edges.
2. The discrete gradient matrix  $G$  representing the edges of the mesh in terms of its vertices.  $G$  has as many rows as the number of edges in the mesh, with each row having two nonzero entries:  $+1$  and  $-1$  in the columns corresponding to the vertices composing the edge. The sign is determined based on the orientation of the edge. We require that  $G$  includes all (interior and boundary) edges and vertices.
3. Vectors  $x$ ,  $y$ , and  $z$  representing the coordinates of the vertices of the mesh.

Internally, ADS proceeds with the construction of the following additional objects:

- $A_C$  – the curl-curl matrix  $C^T \mathbf{A} C$ .
- $\mathbf{\Pi}$  – the matrix representation of the interpolation operator from vector linear to face finite elements.
- $\mathbf{A}_{\mathbf{\Pi}}$  – the vector nodal matrix  $\mathbf{\Pi}^T \mathbf{A} \mathbf{\Pi}$ .
- $B_C$  and  $\mathbf{B}_{\mathbf{\Pi}}$  – efficient (AMS/AMG) solvers for  $A_C$  and  $\mathbf{A}_{\mathbf{\Pi}}$ .

The solution procedure then is a three-level method using smoothing in the original face space and subspace corrections based on  $B_C$  and  $\mathbf{B}_{\mathbf{\Pi}}$ . We can employ a number of options here utilizing various combinations of the smoother and solvers in additive or multiplicative fashion.

### 6.10.2 Sample Usage

ADS can be used either as a solver or as a preconditioner. Below we list the sequence of *hypre* calls needed to create and use it as a solver. We start with the allocation of the `HYPRE_Solver` object:

```
HYPRE_Solver solver;
HYPRE_ADSCreate(&solver);
```

Next, we set a number of solver parameters. Some of them are optional, while others are necessary in order to perform the solver setup.

The user is required to provide the discrete curl and gradient matrices  $C$  and  $G$ . ADS expects a matrix defined on the whole mesh with no boundary faces, edges or nodes excluded. It is essential to **not** impose any boundary conditions on  $C$  or  $G$ . Regardless of which *hypre* conceptual interface was used to construct the matrices, one can always obtain a ParCSR version of them. This is the expected format in the following functions.

```
HYPRE_ADSSetDiscreteCurl(solver, C);
HYPRE_ADSSetDiscreteGradient(solver, G);
```

Next, ADS requires the coordinates of the vertices in the mesh as three *hypre* parallel vectors. The corresponding function call reads:

```
HYPRE_ADSSetCoordinateVectors(solver, x, y, z);
```

The remaining solver parameters are optional. For example, the user can choose a different cycle type by calling

```
HYPRE_ADSSetCycleType(solver, cycle_type); /* default value: 1 */
```

The available cycle types in ADS are:

- `cycle_type=1`: multiplicative solver (01210)

- `cycle_type=2`: additive solver (0 + 1 + 2)
- `cycle_type=3`: multiplicative solver (02120)
- `cycle_type=4`: additive solver (010 + 2)
- `cycle_type=5`: multiplicative solver (0102010)
- `cycle_type=6`: additive solver (1 + 020)
- `cycle_type=7`: multiplicative solver (0201020)
- `cycle_type=8`: additive solver (0(1 + 2)0)
- `cycle_type=11`: multiplicative solver (013454310)
- `cycle_type=12`: additive solver (0 + 1 + 3 + 4 + 5)
- `cycle_type=13`: multiplicative solver (034515430)
- `cycle_type=14`: additive solver (01(3 + 4 + 5)10)

Here we use the following convention for the three subspace correction methods: 0 refers to smoothing, 1 stands for AMS based on  $B_C$ , and 2 refers to a call to BoomerAMG for  $\mathbf{B}_\Pi$ . The values 3, 4 and 5 refer to the scalar subspaces corresponding to the  $x$ ,  $y$  and  $z$  components of  $\Pi$ .

The abbreviation  $xyz$  for  $x, y, z \in \{0, 1, 2, 3, 4, 5\}$  refers to a multiplicative subspace correction based on solvers  $x, y, y$ , and  $z$  (in that order). The abbreviation  $x+y+z$  stands for an additive subspace correction method based on  $x, y$  and  $z$  solvers. The additive cycles are meant to be used only when ADS is called as a preconditioner. In our experience the choices `cycle_type=1,5,8,11,13` often produced fastest solution times, while `cycle_type=7` resulted in smallest number of iterations.

Additional solver parameters, such as the maximum number of iterations, the convergence tolerance and the output level, can be set with

```
HYPRE_ADSSetMaxIter(solver, maxit);    /* default value: 20 */
HYPRE_ADSSetTol(solver, tol);          /* default value: 1e-6 */
HYPRE_ADSSetPrintLevel(solver, print); /* default value: 1 */
```

More advanced parameters, affecting the smoothing and the internal AMS and AMG solvers, can be set with the following three functions:

```
HYPRE_ADSSetSmoothingOptions(solver, 2, 1, 1.0, 1.0);
HYPRE_ADSSetAMSOptions(solver, 11, 10, 1, 3, 0.25, 0, 0);
HYPRE_ADSSetAMGOptions(solver, 10, 1, 3, 0.25, 0, 0);
```

We note that the AMS cycle type, which is the second parameter of `HYPRE_ADSSetAMSOptions` should be greater than 10, unless the high-order interface of `HYPRE_ADSSetInterpolations` described in the next subsection is being used.

After the above calls, the solver is ready to be constructed. The user has to provide the stiffness matrix  $\mathbf{A}$  (in ParCSR format) and the *hypr* parallel vectors  $\mathbf{b}$  and  $\mathbf{x}$ . (The vectors are actually not used in the current ADS setup.) The setup call reads,

```
HYPRE_ADSSetup(solver, A, b, x);
```

It is important to note the order of the calling sequence. For example, do **not** call `HYPRE_ADSSetup` before calling each of the functions `HYPRE_ADSSetDiscreteCurl`, `HYPRE_ADSSetDiscreteGradient` and `HYPRE_ADSSetCoordinateVectors`.

Once the setup has completed, we can solve the linear system by calling

```
HYPRE_ADSSolve(solver, A, b, x);
```

Finally, the solver can be destroyed with

```
HYPRE_ADSDestroy(&solver);
```

More details can be found in the files `ads.h` and `ads.c` located in the `parcsr_ls` directory.

### 6.10.3 High-order Discretizations

Similarly to AMS, ADS also provides support for (arbitrary) high-order  $H(\text{div})$  discretizations. Since the robustness of ADS depends on the performance of AMS and BoomerAMG on the associated (high-order) auxiliary subspace problems, we note that the convergence may not be optimal for large polynomial degrees  $k \geq 1$ .

In the high-order ADS interface, the user does not need to provide the coordinates of the vertices, but instead should construct and pass the Raviart-Thomas and Nedelec interpolation matrices  $\mathbf{\Pi}_{RT}$  and  $\mathbf{\Pi}_{ND}$  which map (high-order) vector nodal finite elements into the (high-order) Raviart-Thomas and Nedelec space. In other words, these are the (parallel) matrix representation of the interpolation mappings from  $P_k^3/Q_k^3$  into  $RT_{k-1}$  and  $ND_k$ , see [20, 27]. We require these matrices as inputs, since in the high-order case their entries very much depend on the particular choice of the basis functions in the finite element spaces, as well as on the geometry of the mesh elements. The columns of the  $\mathbf{\Pi}$  matrices should use a node-based numbering, where the  $x/y/z$  components of the first node (vertex or high-order degree of freedom) should be listed first, followed by the  $x/y/z$  components of the second node and so on (see the documentation of `HYPRE_BoomerAMGSetDofFunc`). Furthermore, each interpolation matrix can be split into  $x$ ,  $y$  and  $z$  components by defining  $\mathbf{\Pi}^x \varphi = \mathbf{\Pi}(\varphi, 0, 0)$ , and similarly for  $\mathbf{\Pi}^y$  and  $\mathbf{\Pi}^z$ .

The discrete gradient and curl matrices  $G$  and  $C$  should correspond to the mappings  $\varphi \in P_k^3/Q_k^3 \mapsto \nabla \varphi \in ND_k$  and  $\mathbf{u} \in ND_k \mapsto \nabla \times \mathbf{u} \in RT_{k-1}$ , so even though their values are still independent of the mesh coordinates, they will not be  $\pm 1$ , but will be determined by the particular form of the high-order basis functions and degrees of freedom.

With these matrices, the high-order setup procedure is simply

```
HYPRE_ADSSetDiscreteCurl(solver, C);
HYPRE_ADSSetDiscreteGradient(solver, G);
HYPRE_ADSSetInterpolations(solver, RT_Pi, NULL, NULL, NULL,
                           ND_Pi, NULL, NULL, NULL);
```

We remark that the above interface calls can also be used in the lowest-order case (or even other types of discretizations), but we recommend calling the previously described `HYPRE_ADSSetCoordinateVectors` instead, since this allows ADS to handle the construction and use of the interpolations internally.

Specifying the monolithic  $\mathbf{\Pi}_{RT}$  limits the ADS cycle type options to those less than 10. Alternatively one can separately specify the  $x$ ,  $y$  and  $z$  components of  $\mathbf{\Pi}_{RT}$ .

```
HYPRE_ADSSetInterpolations(solver, NULL, RT_Pix, RT_Piy, RT_Piz,
                           ND_Pi, NULL, NULL, NULL);
```

which enables the use of ADS cycle types with index greater than 10. The same holds for  $\mathbf{\Pi}_{ND}$  and its components, e.g. to enable the subspace AMS cycle type greater than 10 we need to call

```
HYPRE_ADSSetInterpolations(solver, NULL, RT_Pix, RT_Piy, RT_Piz,
                           NULL, ND_Pix, ND_Piy, ND_Piz);
```

Finally, both  $\mathbf{\Pi}$  and their components can be passed to the solver:

```
HYPRE_ADSSetInterpolations(solver, RT_Pi, RT_Pix, RT_Piy, RT_Piz
                           ND_Pi, ND_Pix, ND_Piy, ND_Piz);
```

which will duplicate some memory, but allows for experimentation with all available ADS and AMS cycle types.

## 6.11 The MLI Package

MLI is an object-oriented module that implements the class of algebraic multigrid algorithms based on Vanek and Brezina's smoothed aggregation method [34, 33]. There are two main algorithms in this module - the original smoothed aggregation algorithm and the modified version that uses the finite element substructure matrices to construct the prolongation operators. As such, the later algorithm can only be used in the finite element context via the finite element interface. In addition, the nodal coordinates obtained via the finite element interface can be used to construct a better prolongation operator than the pure translation modes.

Below is an example on how to set up MLI as a preconditioner for conjugate gradient.

```
HYPRE_LSI_MLICreate(MPI_COMM_WORLD, &pcg_precond);

HYPRE_LSI_MLISetParams(pcg_precond, "MLI strengthThreshold 0.08");
...

HYPRE_PCGSetPrecond(pcg_solver,
                    (HYPRE_PtrToSolverFcn) HYPRE_LSI_MLISolve,
                    (HYPRE_PtrToSolverFcn) HYPRE_LSI_MLISetup,
                    pcg_precond);
```

Note that parameters are set via `HYPRE_LSI_MLISetParams`. A list of valid parameters that can be set using this routine can be found in the FEI section of the reference manual.

## 6.12 ParaSails

ParaSails is a parallel implementation of a sparse approximate inverse preconditioner, using *a priori* sparsity patterns and least-squares (Frobenius norm) minimization. Symmetric positive definite (SPD) problems are handled using a factored SPD sparse approximate inverse. General (nonsymmetric and/or indefinite) problems are handled with an unfactored sparse approximate inverse. It is also possible to precondition nonsymmetric but definite matrices with a factored, SPD preconditioner.

ParaSails uses *a priori* sparsity patterns that are patterns of powers of sparsified matrices. ParaSails also uses a post-filtering technique to reduce the cost of applying the preconditioner. In advanced usage not described here, the pattern of the preconditioner can also be reused to generate preconditioners for different matrices in a sequence of linear solves.

For more details about the ParaSails algorithm, see [7].

### 6.12.1 Parameter Settings

The accuracy and cost of ParaSails are parametrized by the real *thresh* and integer *nlevels* parameters,  $0 \leq \text{thresh} \leq 1$ ,  $0 \leq \text{nlevels}$ . Lower values of *thresh* and higher values of *nlevels* lead to more accurate, but more expensive preconditioners. More accurate preconditioners are also more expensive per iteration. The default values are *thresh* = 0.1 and *nlevels* = 1. The parameters are set using `HYPRE_ParaSailsSetParams`.

Mathematically, given a symmetric matrix  $A$ , the pattern of the approximate inverse is the pattern of  $\tilde{A}^m$  where  $\tilde{A}$  is a matrix that has been sparsified from  $A$ . The sparsification is performed by dropping all entries in a symmetrically diagonally scaled  $A$  whose values are less than *thresh* in magnitude. The parameter *nlevel* is equivalent to  $m + 1$ . Filtering is a post-thresholding procedure. For more details about the algorithm, see [7].

The storage required for the ParaSails preconditioner depends on the parameters *thresh* and *nlevels*. The default parameters often produce a preconditioner that can be stored in less than the space required to store the original matrix. ParaSails does not need a large amount of intermediate storage in order to construct the preconditioner.

ParaSail's Create function differs from the synopsis in the following way:

```
int HYPRE_ParaSailsCreate(MPI_Comm comm, HYPRE_Solver *solver,
    int symmetry);
```

where `comm` is the MPI communicator.

The value of `symmetry` has the following meanings, to indicate the symmetry and definiteness of the problem, and to specify the type of preconditioner to construct:

value	meaning
0	nonsymmetric and/or indefinite problem, and nonsymmetric preconditioner
1	SPD problem, and SPD (factored) preconditioner
2	nonsymmetric, definite problem, and SPD (factored) preconditioner



For more information about the final case, see section 6.12.2.

Parameters for setting up the preconditioner are specified using

```
int HYPRE_ParaSailsSetParams(HYPRE_Solver solver,
    double thresh, int nlevel, double filter);
```

The parameters are used to specify the sparsity pattern and filtering value (see above), and are described with suggested values as follows:

parameter	type	range	sug. values	default	meaning
<b>nlevel</b>	integer	$\mathbf{nlevel} \geq 0$	0, 1, 2	1	$m = \mathbf{nlevel} + 1$
<b>thresh</b>	real	$\mathbf{thresh} \geq 0$ $\mathbf{thresh} < 0$	0, 0.1, 0.01 -0.75, -0.90	0.1	$\mathit{thresh} = \mathbf{thresh}$ $\mathit{thresh}$ selected automatically
<b>filter</b>	real	$\mathbf{filter} \geq 0$ $\mathbf{filter} < 0$	0, 0.05, 0.001 -0.90	0.05	filter value = $\mathbf{filter}$ filter value selected automatically

When  $\mathbf{thresh} < 0$ , then a threshold is selected such that  $-\mathbf{thresh}$  represents the fraction of the nonzero elements that are dropped. For example, if  $\mathbf{thresh} = -0.9$  then  $\tilde{A}$  will contain approximately ten percent of the nonzeros in  $A$ .

When  $\mathbf{filter} < 0$ , then a filter value is selected such that  $-\mathbf{filter}$  represents the fraction of the nonzero elements that are dropped. For example, if  $\mathbf{filter} = -0.9$  then approximately 90 percent of the entries in the computed approximate inverse are dropped.

### 6.12.2 Preconditioning Nearly Symmetric Matrices

A nonsymmetric, but definite and nearly symmetric matrix  $A$  may be preconditioned with a symmetric preconditioner  $M$ . Using a symmetric preconditioner has a few advantages, such as guaranteeing positive definiteness of the preconditioner, as well as being less expensive to construct.

The nonsymmetric matrix  $A$  must be definite, i.e.,  $(A + A^T)/2$  is SPD, and the *a priori* sparsity pattern to be used must be symmetric. The latter may be guaranteed by 1) constructing the sparsity pattern with a symmetric matrix, or 2) if the matrix is structurally symmetric (has symmetric pattern), then thresholding to construct the pattern is not used (i.e., zero value of the **thresh** parameter is used).

## 6.13 Euclid

The Euclid library is a scalable implementation of the Parallel ILU algorithm that was presented at SC99 [21], and published in expanded form in the SIAM Journal on Scientific Computing [22]. By *scalable* we mean that the factorization (setup) and application (triangular solve) timings remain nearly constant when the global problem size is scaled in proportion to the number of processors. As with all ILU preconditioning methods, the number of iterations is expected to increase with global problem size.

Experimental results have shown that PILU preconditioning is in general more effective than Block Jacobi preconditioning for minimizing total solution time. For scaled problems, the relative

advantage appears to increase as the number of processors is scaled upwards. Euclid may also be used to good advantage as a smoother within multigrid methods.

### 6.13.1 Overview

Euclid is best thought of as an “extensible ILU preconditioning framework.” *Extensible* means that Euclid can (and eventually will, time and contributing agencies permitting) support many variants of  $ILU(k)$  and ILUT preconditioning. (The current release includes Block Jacobi  $ILU(k)$  and Parallel  $ILU(k)$  methods.) Due to this extensibility, and also because Euclid was developed independently of the *hypre* project, the methods by which one passes runtime parameters to Euclid preconditioners differ in some respects from the *hypre* norm. While users can directly set options within their code, options can also be passed to Euclid preconditioners via command line switches and/or small text-based configuration files. The latter strategies have the advantage that users will not need to alter their codes as Euclid’s capabilities are extended.

The following fragment illustrates the minimum coding required to invoke Euclid preconditioning within *hypre* application contexts. The next subsection provides examples of the various ways in which Euclid’s options can be set. The final subsection lists the options, and provides guidance as to the settings that (in our experience) will likely prove effective for minimizing execution time.

```
#include "HYPRE_parcsr_ls.h"

HYPRE_Solver eu;
HYPRE_Solver pcg_solver;
HYPRE_ParVector b, x;
HYPRE_ParCSRMatrix A;

//Instantiate the preconditioner.
HYPRE_EuclidCreate(comm, &eu);

//Optionally use the following three methods to set runtime options.
// 1. pass options from command line or string array.
HYPRE_EuclidSetParams(eu, argc, argv);

// 2. pass options from a configuration file.
HYPRE_EuclidSetParamsFromFile(eu, "filename");

// 3. pass options using interface functions.
HYPRE_EuclidSetLevel(eu, 3);
...

//Set Euclid as the preconditioning method for some
//other solver, using the function calls HYPRE_EuclidSetup
//and HYPRE_EuclidSolve. We assume that the pcg_solver
```

```

//has been properly initialized.
HYPRE_PCGSetPrecond(pcg_solver,
                    (HYPRE_PtrToSolverFcn) HYPRE_EuclidSolve,
                    (HYPRE_PtrToSolverFcn) HYPRE_EuclidSetup,
                    eu);

//Solve the system by calling the Setup and Solve methods for,
//in this case, the HYPRE_PCG solver. We assume that A, b, and x
//have been properly initialized.
HYPRE_PCGSetup(pcg_solver, (HYPRE_Matrix)A, (HYPRE_Vector)b, (HYPRE_Vector)x);
HYPRE_PCGSolve(pcg_solver, (HYPRE_Matrix)parcsr_A, (HYPRE_Vector)b, (HYPRE_Vector)x);

//Destroy the Euclid preconditioning object.
HYPRE_EuclidDestroy(eu);

```

### 6.13.2 Setting Options: Examples

For expositional purposes, assume you wish to set the  $ILU(k)$  factorization level to the value  $k = 3$ . There are several methods of accomplishing this. Internal to Euclid, options are stored in a simple database that contains (name, value) pairs. Various of Euclid's internal (private) functions query this database to determine, at runtime, what action the user has requested. If you enter the option “-eu\_stats 1”, a report will be printed when Euclid's destructor is called; this report lists (among other statistics) the options that were in effect during the factorization phase.

**Method 1.** By default, Euclid always looks for a file titled “database” in the working directory. If it finds such a file, it opens it and attempts to parse it as a configuration file. Configuration files should be formatted as follows.

```

>cat database
#this is an optional comment
-level 3

```

Any line in a configuration file that contains a “#” character in the first column is ignored. All other lines should begin with an option *name*, followed by one or more blanks, followed by the option *value*. Note that option names always begin with a “-” character. If you include an option name that is not recognized by Euclid, no harm should ensue.

**Method 2.** To pass options on the command line, call

```
HYPRE_EuclidSetParams(HYPRE_Solver solver, int argc, char *argv[]);
```

where `argc` and `argv` carry the usual connotation: `main(int argc, char *argv[])`. If your *hypr*e application is called *phoo*, you can then pass options on the command line per the following example.

```
mpirun -np 2 phoo -level 3
```

Since Euclid looks for the “database” file when `HYPRE_EuclidCreate` is called, and parses the command line when `HYPRE_EuclidSetParams` is called, option values passed on the command line will override any similar settings that may be contained in the “database” file. Also, if same option name appears more than once on the command line, the final appearance determines the setting.

Some options, such as “-bj” (see next subsection) are boolean. Euclid always treats these options as the value “1” (true) or “0” (false). When passing boolean options from the command line the value may be committed, in which case it assumed to be “1.” Note, however, that when boolean options are contained in a configuration file, either the “1” or “0” must stated explicitly.

**Method 3.** There are two ways in which you can read in options from a file whose name is other than “database.” First, you can call `HYPRE_EuclidSetParamsFromFile` to specify a configuration filename. Second, if you have passed the command line arguments as described above in Method 2, you can then specify the configuration filename on the command line using the `-db_filename filename` option, e.g.,

```
mpirun -np 2 phoo -db_filename ../myConfigFile
```

**Method 4.** One can also set parameters via interface functions, e.g

```
int HYPRE_EuclidSetLevel(HYPRE_Solver solver, int level);
```

For a full set of functions, see the reference manual.

### 6.13.3 Options Summary

- level**  $\langle int \rangle$  Factorization level for ILU( $k$ ). Default: 1. Guidance: for 2D convection-diffusion and similar problems, fastest solution time is typically obtained with levels 4 through 8. For 3D problems fastest solution time is typically obtained with level 1.
- bj** Use Block Jacobi ILU preconditioning instead of PILU. Default: 0 (false). Guidance: if subdomains contain relatively few nodes (less than 1,000), or the problem is not well partitioned, Block Jacobi ILU may give faster solution time than PILU.
- eu\_stats** When Euclid’s destructor is called a summary of runtime settings and timing information is printed to stdout. Default: 0 (false). The timing marks in the report are the maximum over all processors in the MPI communicator.
- eu\_mem** When Euclid’s destructor is called a summary of Euclid’s memory usage is printed to stdout. Default: 0 (false). The statistics are for the processor whose rank in MPI.COMM\_WORLD is 0.
- printTestData** This option is used in our autotest procedures, and should not normally be invoked by users.
- sparseA**  $\langle float \rangle$  Drop-tolerance for ILU( $k$ ) factorization. Default: 0 (no dropping). Entries are treated as zero if their absolute value is less than (sparseA \* max), where “max” is the largest absolute value of any entry in the row. Guidance: try this in conjunction with -rowScale.

CAUTION: If the coefficient matrix  $A$  is symmetric, this setting is likely to cause the filled matrix,  $F = L + U - I$ , to be unsymmetric. This setting has no effect when ILUT factorization is selected.

**-rowScale** Scale values prior to factorization such that the largest value in any row is +1 or -1. Default: 0 (false). CAUTION: If the coefficient matrix  $A$  is symmetric, this setting is likely to cause the filled matrix,  $F = L + U - I$ , to be unsymmetric. Guidance: if the matrix is poorly scaled, turning on row scaling may help convergence.

**-ilut**  $\langle float \rangle$  Use ILUT factorization instead of the default,  $ILU(k)$ . Here,  $\langle float \rangle$  is the drop tolerance, which is relative to the largest absolute value of any entry in the row being factored. CAUTION: If the coefficient matrix  $A$  is symmetric, this setting is likely to cause the filled matrix,  $F = L + U - I$ , to be unsymmetric. NOTE: this option can only be used sequentially!

## 6.14 PILUT: Parallel Incomplete Factorization

**Note:** this code is no longer supported by the *hypre* team. We recommend to use Euclid instead, which is more versatile and in general more efficient, especially when used with many processors.

*PILUT* is a parallel preconditioner based on Saad's dual-threshold incomplete factorization algorithm. The original version of *PILUT* was done by Karypis and Kumar [24] in terms of the Cray SHMEM library. The code was subsequently modified by the *hypre* team: SHMEM was replaced by MPI; some algorithmic changes were made; and it was software engineered to be interoperable with several matrix implementations, including *hypre*'s ParCSR format, PETSc's matrices, and ISIS++ RowMatrix. The algorithm produces an approximate factorization  $LU$ , with the preconditioner  $M$  defined by  $M = LU$ .

**Note:** *PILUT* produces a nonsymmetric preconditioner even when the original matrix is symmetric. Thus, it is generally inappropriate for preconditioning symmetric methods such as Conjugate Gradient.

### Parameters:

- **SetMaxNonzerosPerRow( int LFIL );** (Default: 20) Set the maximum number of nonzeros to be retained in each row of  $L$  and  $U$ . This parameter can be used to control the amount of memory that  $L$  and  $U$  occupy. Generally, the larger the value of LFIL, the longer it takes to calculate the preconditioner and to apply the preconditioner and the larger the storage requirements, but this trades off versus a higher quality preconditioner that reduces the number of iterations.
- **SetDropTolerance( double tol );** (Default: 0.0001) Set the tolerance (relative to the 2-norm of the row) below which entries in  $L$  and  $U$  are automatically dropped. *PILUT* first drops entries based on the drop tolerance, and then retains the largest LFIL elements in each

row that remain. Smaller values of `tol` lead to more accurate preconditioners, but can also lead to increases in the time to calculate the preconditioner.

## 6.15 LOBPCG Eigensolver

LOBPCG (Locally Optimal Block Preconditioned Conjugate Gradient) is a simple, yet very efficient, algorithm suggested in [25, 26, 5] for computing several smallest eigenpairs of the symmetric generalized eigenvalue problem  $Ax = \lambda Bx$  with large, possibly sparse, symmetric matrix  $A$  and symmetric positive definite matrix  $B$ . The matrix  $A$  is not assumed to be positive, which also allows one to use LOBPCG to compute the largest eigenpairs of  $Ax = \lambda Bx$  simply by solving  $-Ax = \mu Bx$  for the smallest eigenvalues  $\mu = -\lambda$ .

LOBPCG simultaneously computes several eigenpairs together, which is controlled by the `blockSize` parameter, see example `ex11.c`. The LOBPCG also allows one to impose constraints on the eigenvectors of the form  $x^T B y_i = 0$  for a set of vectors  $y_i$  given to LOBPCG as input parameters. This makes it possible to compute, e.g., 50 eigenpairs by 5 subsequent calls to LOBPCG with the `blockSize=10`, using deflation. LOBPCG can use preconditioning in two different ways: by running an inner preconditioned PCG linear solver, or by applying the preconditioner directly to the eigenvector residual (option `-pcgitr 0`). In all other respects, LOBPCG is similar to the PCG linear solver.

The LOBPCG code is available for system interfaces: `Struct`, `SStruct`, and `IJ`. It is also used in the Auxiliary-space Maxwell Eigensolver (AME). The LOBPCG setup is similar to the setup for PCG.

## 6.16 FEI Solvers

After the FEI has been used to assemble the global linear system (as described in Chapter 4), a number of *hypre* solvers can be called to perform the solution. This is straightforward, if *hypre*'s FEI has been used. If an external FEI is employed, the user needs to link with *hypre*'s implementation of the `LinearSystemCore` class, as described in Section 7.7.

Solver parameters are specified as an array of strings, and a complete list of the available options can be found in the FEI section of the reference manual. They are passed to the FEI as in the following example:

```
nParams = 5;
paramStrings = new char*[nParams];
for (i = 0; i < nParams; i++) {
    paramStrings[i] = new char[100];

    strcpy(paramStrings[0], "solver cg");
    strcpy(paramStrings[1], "preconditioner diag");
    strcpy(paramStrings[2], "maxiterations 100");
    strcpy(paramStrings[3], "tolerance 1.0e-6");
```

```
strcpy(paramStrings[4], "outputLevel 1");

feiPtr -> parameters(nParams, paramStrings);
```

To solve the linear system of equations, we call

```
feiPtr -> solve(&status);
```

where the returned value `status` indicates whether the solve was successful.

Finally, the solution can be retrieved by the following function call:

```
feiPtr -> getBlockNodeSolution(elemBlkID, nNodes, nodeIDList,
                               solnOffsets, solnValues);
```

where `nodeIDList` is a list of nodes in element block `elemBlkID`, and `solnOffsets[i]` is the index pointing to the first location where the variables at node  $i$  is returned in `solnValues`.

### 6.16.1 Solvers Available Only through the FEI

While most of the solvers from the previous sections are available through the FEI interface, there are number of additional solvers and preconditioners that are accessible only through the FEI. These solvers are briefly described in this section (see also the reference manual).

#### Sequential and Parallel Solvers

*hypre* currently has many iterative solvers. There is also internally a version of the sequential SuperLU direct solver (developed at U.C. Berkeley) suitable to small problems (may be up to the size of 10000). In the following we list some of these internal solvers.

1. Additional Krylov solvers (FGMRES, TFQMR, symmetric QMR),
2. SuperLU direct solver (sequential),
3. SuperLU direct solver with iterative refinement (sequential),

#### Parallel Preconditioners

The performance of the Krylov solvers can be improved by clever selection of preconditioners. Besides those mentioned previously in this chapter, the following preconditioners are available via the `LinearSystemCore` interface:

1. the modified version of MLI, which requires the finite element substructure matrices to construct the prolongation operators,
2. parallel domain decomposition with inexact local solves (DDIut),
3. least-squares polynomial preconditioner,

4.  $2 \times 2$  block preconditioner, and
5.  $2 \times 2$  Uzawa preconditioner.

Some of these preconditioners can be tuned by a number of internal parameters modifiable by users. A description of these parameters is given in the reference manual.

### Matrix Reduction

For some structural mechanics problems with multi-point constraints the discretization matrix is indefinite (eigenvalues lie in both sides of the imaginary axis). Indefinite matrices are much more difficult to solve than definite matrices. Methods have been developed to reduce these indefinite matrices to definite matrices. Two matrix reduction algorithms have been implemented in *hypra*, as presented in the following subsections.

### Schur Complement Reduction

The incoming linear system of equations is assumed to be in the form :

$$\begin{bmatrix} D & B \\ B^T & 0 \end{bmatrix} \begin{bmatrix} x_1 \\ x_2 \end{bmatrix} = \begin{bmatrix} b_1 \\ b_2 \end{bmatrix}$$

where  $D$  is a diagonal matrix. After Schur complement reduction is applied, the resulting linear system becomes

$$-B^T D^{-1} B x_2 = b_2 - B^T D^{-1} b_1.$$

### Slide Surface Reduction

With the presence of slide surfaces, the matrix is in the same form as in the case of Schur complement reduction. Here  $A$  represents the relationship between the master, slave, and other degrees of freedom. The matrix block  $[B^T 0]$  corresponds to the constraint equations. The goal of reduction is to eliminate the constraints. As proposed by Manteuffel, the trick is to re-order the system into a  $3 \times 3$  block matrix.

$$\begin{bmatrix} A_{11} & A_{12} & N \\ A_{21} & A_{22} & D \\ N^T & D & 0 \end{bmatrix} = \begin{bmatrix} A_{11} & \hat{A}_{12} \\ \hat{A}_{21} & \hat{A}_{22} \end{bmatrix}$$

The reduced system has the form :

$$(A_{11} - \hat{A}_{21} \hat{A}_{22}^{-1} \hat{A}_{12}) x_1 = b_1 - \hat{A}_{21} \hat{A}_{22}^{-1} b_2,$$

which is symmetric positive definite (SPD) if the original matrix is PD. In addition,  $\hat{A}_{22}^{-1}$  is easy to compute.

There are three slide surface reduction algorithms in *hypra*. The first follows the matrix formulation in this section. The second is similar except that it replaces the eliminated slave equations with identity rows so that the degree of freedom at each node is preserved. This is essential for



certain block algorithms such as the smoothed aggregation multilevel preconditioners. The third is similar to the second except that it is more general and can be applied to problems with intersecting slide surfaces (sequential only for intersecting slide surfaces).

### Other Features

To improve the efficiency of the *hypr*e solvers, a few other features have been incorporated. We list a few of these features below :

1. Preconditioner reuse - For multiple linear solves with matrices that are slightly perturbed from each other, oftentimes the use of the same preconditioners can save preconditioner setup times but suffer little convergence rate degradation.
2. Projection methods - For multiple solves that use the same matrix, previous solution vectors can sometimes be used to give a better initial guess for subsequent solves. Two projection schemes have been implemented in *hypr*e - A-conjugate projection (for SPD matrices) and minimal residual projection (for both SPD and non-SPD matrices).
3. The sparsity pattern of the matrix is in general not destroyed after it has been loaded to an *hypr*e matrix. But if the matrix is not to be reused, an option is provided to clean up this pattern matrix to conserve memory usage.



# Chapter 7

## General Information

### 7.1 Getting the Source Code

The *hypre* distribution tar file is available from the Software link of the *hypre* web page, <http://www.llnl.gov/CASC/hypre/>. The *hypre* Software distribution page allows access to the tar files of the latest and previous general and beta distributions as well as documentation.

### 7.2 Building the Library

In this and the following several sections, we discuss the steps to install and use *hypre* on a Unix-like operating system, such as Linux, AIX, and Mac OS X. Alternatively, the CMake build system [8] can be used, and is the best approach for building *hypre* on Windows systems in particular (see the `INSTALL` file for details).

After unpacking the *hypre* tar file, the source code will be in the “src” sub-directory of a directory named `hypre-VERSION`, where `VERSION` is the current version number (e.g., `hypre-1.8.4`, with a “b” appended for a beta release).

Move to the “src” sub-directory to build *hypre* for the host platform. The simplest method is to configure, compile and install the libraries in `./hypre/lib` and `./hypre/include` directories, which is accomplished by:

```
./configure
make
```

NOTE: when executing on an IBM platform `configure` must be executed under the `nopoe` script (`./nopoe ./configure <option> ...<option>`) to force a single task to be run on the log-in node.

There are many options to `configure` and `make` to customize such things as installation directories, compilers used, compile and load flags, etc.

Executing `configure` results in the creation of platform specific files that are used when building the library. The information may include such things as the system type being used for building and executing, compilers being used, libraries being searched, option flags being set, etc. When all

of the searching is done two files are left in the `src` directory; `config.status` contains information to recreate the current configuration and `config.log` contains compiler messages which may help in debugging `configure` errors.

Upon successful completion of `configure` the file `config/Makefile.config` is created from its template `config/Makefile.config.in` and `hypre` is ready to be built.

Executing `make`, with or without targets being specified, in the `src` directory initiates compiling of all of the source code and building of the `hypre` library. If any errors occur while compiling, the user can edit the file `config/Makefile.config` directly then run `make` again; without having to re-run `configure`.

When building `hypre` without the `install` target, the libraries and include files will be copied into the default directories, `src/hypre/lib` and `src/hypre/include`, respectively.

When building `hypre` using the `install` target, the libraries and include files will be copied into the directories that the user specified in the options to `configure`, e.g. `--prefix=/usr/apps`. If none were specified the default directories, `src/hypre/lib` and `src/hypre/include`, are used.

### 7.2.1 Configure Options

There are many options to `configure` to allow the user to override and refine the defaults for any system. The best way to find out what options are available is to display the help package, by executing `./configure --help`, which also includes the usage information. The user can mix and match the configure options and variable settings to meet their needs.

Some of the commonly used options include:

<code>--enable-debug</code>	Sets compiler flags to generate information needed for debugging.
<code>--enable-shared</code>	Build shared libraries. NOTE: in order to use the resulting shared libraries the user MUST have the path to the libraries defined in the environment variable <code>LD_LIBRARY_PATH</code> .
<code>--with-print-errors</code>	Print HYPRE errors
<code>--enable-global-partition</code>	Store a global partition of the data NOTE: this option may produce faster code on small numbers of processors (< 100), but is not recommended in general.

The user can mix and match the configure options and variable settings to meet their needs. It should be noted that `hypre` can be configured with external BLAS and LAPACK libraries, which can be combined with any other option. This is done as follows (currently, both libraries must be configured as external together):

```
./configure --with-blas-lib="blas-lib-name" --with-blas-lib-dirs="path-to-blas-lib" \
--with-lapack-lib="lapack-lib-name" --with-lapack-lib-dirs="path-to-lapack-lib"
```

The output from `configure` is several pages long. It reports the system type being used for building and executing, compilers being used, libraries being searched, option flags being set, etc.

### 7.2.2 Make Targets

The make step in building *hypre* is where the compiling, loading and creation of libraries occurs. Make has several options that are called targets. These include:

```

help          prints the details of each target

all           default target in all directories
              compile the entire library
              does NOT rebuild documentation

clean        deletes all files from the current directory that are
              created by building the library

distclean    deletes all files from the current directory that are created
              by configuring or building the library

install      compile the source code, build the library and copy executables,
              libraries, etc to the appropriate directories for user access

uninstall    deletes all files that the install target created

tags         runs etags to create a tags table
              file is named TAGS and is saved in the top-level directory

test         depends on the all target to be completed
              removes existing temporary installation directories
              creates temporary installation directories
              copies all libHYPRE* and *.h files to the temporary locations
              builds the test drivers; linking to the temporary locations to
              simulate how application codes will link to HYPRE

```

## 7.3 Testing the Library

The `examples` subdirectory contains several codes that can be used to test the newly created *hypre* library. To create the executable versions, move into the `examples` subdirectory, enter `make` then execute the codes as described in the initial comments section of each source code.

## 7.4 Linking to the Library

An application code linking with *hypre* must be compiled with `-I$PREFIX/include` and linked with `-L$PREFIX/lib -lhypre`, where `$PREFIX` is the directory where *hypre* is installed, default is `hypre`, or as defined by the configure option `--prefix=PREFIX`. As noted above, if *hypre* was built as a shared library the user MUST have its location defined in the environment variable `LD_LIBRARY_PATH`.

As an example of linking with *hypre*, a user may refer to the `Makefile` in the `examples` sub-directory. It is designed to build codes similar to user applications that link with and call *hypre*. All include and linking flags are defined in the `Makefile.config` file by `configure`.

## 7.5 Error Flags

Every *hypre* function returns an integer, which is used to indicate errors during execution. Note that the error flag returned by a given function reflects the errors from *all* previous calls to *hypre* functions. In particular, a value of zero means that all *hypre* functions up to (and including) the current one have completed successfully. This new error flag system is being implemented throughout the library, but currently there are still functions that do not support it. The error flag value is a combination of one or a few of the following error codes:

1. `HYPRE_ERROR_GENERIC` – describes a generic error
2. `HYPRE_ERROR_MEMORY` – *hypre* was unable to allocate memory
3. `HYPRE_ERROR_ARG` – error in one of the arguments of a *hypre* function
4. `HYPRE_ERROR_CONV` – a *hypre* solver did not converge as expected

One can use the `HYPRE_CheckError` function to determine exactly which errors have occurred:

```
/* call some HYPRE functions */
hypre_ierr = HYPRE_Function();
/* check if the previously called hypre functions returned error(s) */
if (hypre_ierr)
    /* check if the error with code HYPRE_ERROR_CODE has occurred */
    if (HYPRE_CheckError(hypre_ierr,HYPRE_ERROR_CODE))
```

The corresponding FORTRAN code is

```
C header file with hypre error codes
    include 'HYPRE_error_f.h'
C call some HYPRE functions
    call HYPRE_Function(..., hypre_ierr);
C check if the previously called hypre functions returned error(s)
    if (hypre_ierr .ne. 0) then
```

```
C check if the error with code HYPRE_ERROR_CODE has occurred
    HYPRE_CheckError(hypre_ierr,HYPRE_ERROR_CODE,check)
    if (check .ne. 0) then
```

The global error flag can also be obtained directly, between calls to other *hypre* functions, by calling `HYPRE_GetError()`. If an argument error (`HYPRE_ERROR_ARG`) has occurred, the argument index (counting from 1) can be obtained from `HYPRE_GetErrorArg()`. To get a character string with a description of all errors in a given error flag, use

```
HYPRE_DescribeError(int hypre_ierr, char *descr);
```

The global error flag can be cleared manually by calling `HYPRE_ClearAllErrors()`, which will essentially ignore all previous *hypre* errors. To only clear a specific error code, the user can call `HYPRE_ClearError(HYPRE_ERROR_CODE)`. Finally, if *hypre* was configured with `--with-print-errors`, additional error information will be printed to the standard error during execution.

## 7.6 Bug Reporting and General Support

Simply send an email to `hypre-support@llnl.gov` to report bugs, request features, or ask general usage questions. An *issue number* will be assigned to your email so that we can track progress (we are using an issue tracking tool called Roundup to do this).

Users should include as much relevant information as possible in their issue emails, including at a minimum, the *hypre* version number being used. For compile and runtime problems, please also include the machine type, operating system, MPI implementation, compiler, and any error messages produced.

## 7.7 Using HYPRE in External FEI Implementations

To set up *hypre* for use in external, e.g. Sandia's, FEI implementations one needs to follow the following steps:

1. obtain the *hypre* and Sandia's FEI source codes,
2. compile Sandia's FEI (fei-2.5.0) to create the `fei_base` library.
3. compile *hypre*
  - (a) unpack the archive and go into the `src` directory
  - (b) do a 'configure' with the `--with-fei-inc-dir` option set to the FEI include directory plus other compile options
  - (c) compile with `make install` to create the HYPRE LSI library in `hypre/lib`.
4. call the FEI functions in your application code (as shown in Chapters 4 and 6)
  - (a) include `cfei-hypre.h` in your file

- (b) include `FEI_Implementation.h` in your file
5. Modify your `Makefile`
- (a) include `hypre's include` and `lib` directories in the search paths.
  - (b) Link with `-lfei_base -lHYPRE_LSI`. Note that the order in which the libraries are listed may be important.

Building an application executable often requires linking with many different software packages, and many software packages use some LAPACK and/or BLAS functions. In order to alleviate the problem of multiply defined functions at link time, it is recommended that all software libraries are stripped of all LAPACK and BLAS function definitions. These LAPACK and BLAS functions should then be resolved at link time by linking with the system LAPACK and BLAS libraries (e.g. `dxml` on DEC cluster). Both `hypre` and SuperLU were built with this in mind. However, some other software library files needed may have the BLAS functions defined in them. To avoid the problem of multiply defined functions, it is recommended that the offending library files be stripped of the BLAS functions.

## 7.8 Calling HYPRE from Other Languages

The `hypre` library currently supports two languages: C (native) and Fortran (in version 2.10.1 and earlier, additional language interfaces were also provided through a tool called Babel). The Fortran interface is manually supported to mirror the “native” C interface used throughout most of this manual. We describe this interface next.

Typically, the Fortran subroutine name is the same as the C name, unless it is longer than 31 characters. In these situations, the name is condensed to 31 characters, usually by simple truncation. For now, users should look at the Fortran test drivers (`*.f` codes) in the `test` directory for the correct condensed names. In the future, this aspect of the interface conversion will be made consistent and straightforward.

The Fortran subroutine argument list is always the same as the corresponding C routine, except that the error return code `ierr` is always last. Conversion from C parameter types to Fortran argument type is summarized in Table 7.1.

Array arguments in `hypre` are always of type `(int *)` or `(double *)`, and the corresponding Fortran types are simply `integer` or `double precision` arrays. Note that the Fortran arrays may be indexed in any manner. For example, an integer array of length `N` may be declared in Fortran as either of the following:

```
integer array(N)
integer array(0:N-1)
```

`hypre` objects can usually be declared as in the table because `integer*8` usually corresponds to the length of a pointer. However, there may be some machines where this is not the case. On such machines, the Fortran type for a `hypre` object should be an `integer` of the appropriate length.

This simple example illustrates the above information:



C parameter	Fortran argument
int i	integer i
double d	double precision d
int *array	integer array(*)
double *array	double precision array(*)
char *string	character string(*)
HYPRE_Type object	integer*8 object
HYPRE_Type *object	integer*8 object

Table 7.1: Conversion from C parameters to Fortran arguments

C prototype:

```
int HYPRE_IJMatrixSetValues(HYPRE_IJMatrix matrix,
                           int nrows, int *ncols,
                           const int *rows, const int *cols,
                           const double *values);
```

The corresponding Fortran code for calling this routine is as follows:

```
integer*8      matrix,
integer        nrows, ncols(MAX_NCOLS)
integer        rows(MAX_ROWS), cols(MAX_COLS)
double precision values(MAX_COLS)
integer        ierr

call HYPRE_IJMatrixSetValues(matrix, nrows, ncols, rows, cols,
&                             values, ierr)
```



# Bibliography

- [1] S. F. Ashby and R. D. Falgout. A parallel multigrid preconditioned conjugate gradient algorithm for groundwater flow simulations. *Nuclear Science and Engineering*, 124(1):145–159, September 1996. Also available as LLNL Technical Report UCRL-JC-122359. 40
- [2] A. Baker, R. Falgout, T. Kolev, and U. M. Yang. Multigrid smoothers for ultra-parallel computing. *SIAM J. on Sci. Comp.*, 33:2864–2887, 2011. Also available as LLNL technical report LLLNL-JRNL-473191. 45
- [3] A. Baker, T. Kolev, and U. M. Yang. Improving algebraic multigrid interpolation operators for linear elasticity problems. *Numer. Linear Algebra Appl.*, 17:495–517, 2010. Also available as LLNL technical report LLLNL-JRNL-412928. 46
- [4] A.H. Baker, R.D. Falgout, and U.M. Yang. An assumed partition algorithm for determining processor inter-communication. *Parallel Computing*, 32:394–414, 2006. 36
- [5] BLOPEX, parallel preconditioned eigenvalue solvers. <http://code.google.com/p/blopex/>. 64
- [6] P. N. Brown, R. D. Falgout, and J. E. Jones. Semicoarsening multigrid on distributed memory machines. *SIAM J. Sci. Comput.*, 21(5):1823–1834, 2000. Special issue on the Fifth Copper Mountain Conference on Iterative Methods. Also available as LLNL technical report UCRL-JC-130720. 39
- [7] E. Chow. A priori sparsity patterns for parallel sparse approximate inverse preconditioners. *SIAM J. Sci. Comput.*, 21:1804–1822, 2000. 58
- [8] CMake, a cross-platform open-source build system. <http://www.cmake.org/>. 2, 3, 69
- [9] H. De Sterck, R. Falgout, J. Nolting, and U. M. Yang. Distance-two interpolation for parallel algebraic multigrid. *Numer. Linear Algebra Appl.*, 15:115–139, 2008. Also available as LLNL technical report UCRL-JRNL-230844. 44, 45
- [10] H. De Sterck, U. M. Yang, and J. Heys. Reducing complexity in parallel algebraic multigrid preconditioners. *SIAM Journal on Matrix Analysis and Applications*, 27:1019–1039, 2006. Also available as LLNL technical report UCRL-JRNL-206780. 44

- [11] R. L. Clay et al. An annotated reference guide to the Finite Element Interface (FEI) specification, Version 1.0. Technical Report SAND99-8229, Sandia National Laboratories, Livermore, CA, 1999. 29
- [12] R. D. Falgout and J. E. Jones. Multigrid on massively parallel architectures. In E. Dick, K. Rienslagh, and J. Vierendeels, editors, *Multigrid Methods VI*, volume 14 of *Lecture Notes in Computational Science and Engineering*, pages 101–107, Berlin, 2000. Springer. Proc. of the Sixth European Multigrid Conference held in Gent, Belgium, September 27-30, 1999. Also available as LLNL technical report UCRL-JC-133948. 39, 40
- [13] R. D. Falgout, J. E. Jones, and U. M. Yang. Conceptual interfaces in *hypre*. *Future Generation Computer Systems*, 22:239–251, 2006. Special issue on PDE software. Also available as LLNL technical report UCRL-JC-148957. 1
- [14] R. D. Falgout, J. E. Jones, and U. M. Yang. The design and implementation of *hypre*, a library of parallel high performance preconditioners. In A. M. Bruaset and A. Tveito, editors, *Numerical Solution of Partial Differential Equations on Parallel Computers*, pages 267–294. Springer-Verlag, 2006. Also available as LLNL technical report UCRL-JRNL-205459. 1
- [15] Robert D. Falgout and Jacob B. Schroder. Non-galerkin coarse grids for algebraic multigrid. *SIAM J. Sci. Comput.*, 36(3):309–334, 2014. 45
- [16] A. Grayver and Tz. Kolev. Large-scale 3D geo-electromagnetic modeling using parallel adaptive high-order finite element method. *Geophysics*, (submitted). Also available as LLNL technical report LLNL-JRNL-665742. 52, 53
- [17] M. Griebel, B. Metsch, and M. A. Schweitzer. Coarse grid classification - Part II: Automatic coarse grid agglomeration for parallel AMG. Preprint No. 271, Sonderforschungsbereich 611, Universität Bonn, 2006. 44
- [18] M. Griebel, B. Metsch, and M. A. Schweitzer. Coarse grid classification: A parallel coarsening scheme for algebraic multigrid methods. *Numerical Linear Algebra with Applications*, 13(2–3):193–214, 2006. Also available as SFB 611 preprint No. 225, Universität Bonn, 2005. 44
- [19] V. E. Henson and U. M. Yang. BoomerAMG: a parallel algebraic multigrid solver and preconditioner. *Applied Numerical Mathematics*, 41(5):155–177, 2002. Also available as LLNL technical report UCRL-JC-141495. 44
- [20] R. Hiptmair and J. Xu. Nodal auxiliary space preconditioning in  $H(\text{curl})$  and  $H(\text{div})$  spaces. *Numer. Math.*, 2006. to appear. 47, 51, 53, 56
- [21] D. Hysom and A. Pothen. Efficient parallel computation of ILU(k) preconditioners. In *Proceedings of Supercomputing '99*. ACM, November 1999. Published on CDROM, ISBN #1-58113-091-0, ACM Order #415990, IEEE Computer Society Press Order # RS00197. 59
- [22] D. Hysom and A. Pothen. A scalable parallel algorithm for incomplete factor preconditioning. *SIAM J. Sci. Comput.*, 22(6):2194–2215, 2001. 59

- [23] J. Jones and B. Lee. A multigrid method for variable coefficient maxwell's equations. *SIAM J. Sci. Comput.*, 27:1689–1708, 2006. 42
- [24] G. Karypis and V. Kumar. Parallel threshold-based ILU factorization. Technical Report 061, University of Minnesota, Department of Computer Science/Army HPC Research Center, Minneapolis, MN 5455, 1998. 63
- [25] A. Knyazev. Toward the optimal preconditioned eigensolver: Locally optimal block preconditioned conjugate gradient method. *SIAM J. Sci. Comput.*, 23(2):517–541, 2001. 64
- [26] A. Knyazev, I. Lashuk, M. Argentati, and E. Ovchinnikov. Block locally optimal preconditioned eigenvalue solvers (blopex) in hypre and petsc. *SIAM J. Sci. Comput.*, 25(5):2224–2239, 2007. 64
- [27] Tz. Kolev and P. Vassilevski. Parallel auxiliary space AMG for H(curl) problems. *J. Comput. Math.*, 27:604–623, 2009. Special issue on Adaptive and Multilevel Methods in Electromagnetics. UCRL-JRNL-237306. 47, 51, 56
- [28] S. F. McCormick. *Multilevel Adaptive Methods for Partial Differential Equations*, volume 6 of *Frontiers in Applied Mathematics*. SIAM Books, Philadelphia, 1989. 26, 40
- [29] J.E. Morel, Randy M. Roberts, and Mikhail J. Shashkov. A local support-operators diffusion discretization scheme for quadrilateral  $r$ - $z$  meshes. *J. Comp. Physics*, 144:17–51, 1998. 18
- [30] J. W. Ruge and K. Stüben. Algebraic multigrid (AMG). In S. F. McCormick, editor, *Multigrid Methods*, volume 3 of *Frontiers in Applied Mathematics*, pages 73–130. SIAM, Philadelphia, PA, 1987. 43, 44
- [31] S. Schaffer. A semi-coarsening multigrid method for elliptic partial differential equations with highly discontinuous and anisotropic coefficients. *SIAM J. Sci. Comput.*, 20(1):228–242, 1998. 39
- [32] K. Stüben. Algebraic multigrid (AMG): an introduction with applications. In U. Trottenberg, C. Oosterlee, and A. Schüller, editors, *Multigrid*. Academic Press, 2001. 44
- [33] P. Vanek, M. Brezina, and J. Mandel. Convergence of algebraic multigrid based on smoothed aggregation. *Numerische Mathematik*, 88:559–579, 2001. 57
- [34] P. Vaněk, J. Mandel, and M. Brezina. Algebraic multigrid based on smoothed aggregation for second and fourth order problems. *Computing*, 56:179–196, 1996. 57
- [35] P. Vassilevski and U. M. Yang. Reducing communication in algebraic multigrid using additive variants. *Numer. Linear Algebra Appl.*, 21:275–296, 2014. Also available as LLNL technical report LLLNL-JRNL-637872. 46
- [36] U. M. Yang. On the use of relaxation parameters in hybrid smoothers. *Numerical Linear Algebra with Applications*, 11:155–172, 2004. 45

- [37] U. M. Yang. Parallel algebraic multigrid methods - high performance preconditioners. In A. M. Bruaset and A. Tveito, editors, *Numerical Solution of Partial Differential Equations on Parallel Computers*, pages 209–236. Springer-Verlag, 2006. Also available as LLNL technical report UCRL-BOOK-208032. 44
- [38] U. M. Yang. On long range interpolation operators for aggressive coarsening. *Numer. Linear Algebra Appl.*, 17:453–472, 2010. Also available as LLNL technical report LLLNL-JRNL-417371. 44